



145 Royal Crest Court Unit 42 Markham, ON, Canada L3R 9Z4
Tel: 905-477-1166 Fax: 905-477-1782 <http://www.orientdisplay.com>

SPECIFICATION FOR LCD MODULE

Part No.: AMG12864P-G

Rev: F00

Issued Date: 2008-7-21

| Engineering Dept. | | | Customer Approved | |
|-------------------|-----|---------|----------------------|----------|
| Prepared | | Checked | | Approved |
| LCD | LCM | | | |
| | | | | |

Table of Contents

| | |
|--|----|
| 1 General Specifications | 3 |
| 2 Mechanical Diagram | 4 |
| 3 I/O Terminal | 6 |
| 3.1 Pin Description..... | 6 |
| 3.2 Block Diagram and Application Circuit..... | 7 |
| 4 Electro-optical Specifications | 8 |
| 4.1 Absolute Maximum Ratings..... | 8 |
| 4.2 Optical Characteristics ⁽¹⁾ | 8 |
| 4.3 Electrical Characteristics | 8 |
| 4.4 Timing Characteristics | 9 |
| 5 Programming..... | 15 |
| 5.1 Instruction Table..... | 15 |
| 5.2 Display Data RAM | 16 |
| Appendix..... | 17 |
| 1 Packing Method | 17 |
| 2 Definitions of Optical Characteristic..... | 18 |
| 2.1 Contrast Ratio Test | 18 |
| 2.2 Response time..... | 19 |
| 2.3 Viewing Angle | 20 |
| 3 Quality Units | 21 |
| 3.1 Visual and Technological Inspection | 21 |
| 3.2 Visual Inspection Standard: | 22 |
| 3.3 Display Inspection Standard:..... | 24 |
| 4 Reliability-TEST..... | 25 |
| 4.1. Standard Specifications for Reliability | 25 |
| 4.2 Life Time:..... | 26 |

Revision History

| Rev. | Comment | Date |
|------|--|------------|
| A00 | Original Version | 2006-10-18 |
| C00 | Modify the LCD mode to blue mode ,transflective,12:00 | 2006-12-11 |
| D00 | Increase The Luminosity of the Display and type of LED | 2007-10-11 |
| D01 | Modify the LCD Mode to transmissive and Supply Voltage For Logic | 2007-11-6 |
| D02 | Modify a mistake of Active Area | 2007-11-7 |
| F00 | Change the Booster circuit of FPC to 4x boost voltage | 2008-7-21 |

1 General Specifications

| Item | <input checked="" type="checkbox"/> Standard Value | Unit |
|------------------------------|--|------|
| Display Pattern | <input checked="" type="checkbox"/> Graphic <input type="checkbox"/> Character <input type="checkbox"/> Segment <input type="checkbox"/> _____ <input type="checkbox"/> with ICON | |
| Color | <input checked="" type="checkbox"/> Mono. <input type="checkbox"/> Grayscale <input type="checkbox"/> _____ | |
| Module Dimension (W x H x T) | 72.4(W)X87.6(H)X(5.9)(T) | mm |
| Viewing Area (W x H) | 70(W)X37(H) | mm |
| Active Area (W x H) | 65.265(W)X32.625(H) | mm |
| Character Size (W x H) | \ | mm |
| Character Pitch (W x H) | \ | mm |
| DOT Size (W x H) | 0.495(W)• 0.495(H) | mm |
| DOT Pitch (W x H) | 0.51(W)• 0.51(H) | mm |
| LCD Type | <input type="checkbox"/> TN, Positive <input type="checkbox"/> TN, Negative <input type="checkbox"/> HTN, Positive <input type="checkbox"/> HTN, Negative | |
| | <input type="checkbox"/> STN, Yellow-Green <input type="checkbox"/> STN, Gray <input checked="" type="checkbox"/> STN, Blue <input type="checkbox"/> FSTN, Positive <input type="checkbox"/> FSTN, Negative | |
| | <input type="checkbox"/> _____ <input type="checkbox"/> FM LCD <input type="checkbox"/> Color STN | |
| Polarizer Type | <input type="checkbox"/> Transflective <input checked="" type="checkbox"/> Transmissive <input type="checkbox"/> Reflective <input type="checkbox"/> Anti-Glare | |
| View Direction | <input type="checkbox"/> 6H <input checked="" type="checkbox"/> 12H <input type="checkbox"/> _____ | |
| LCD Controller & Driver | ST7565P (or Equivalent) | |
| LCD Driving Method | 1/65duty, 1/9bias | |
| Interface Type | Serial <input type="checkbox"/> I ² C <input checked="" type="checkbox"/> 4-line SPI <input type="checkbox"/> 3-line SPI <input type="checkbox"/> _____ | |
| | Parallel <input checked="" type="checkbox"/> 6800 <input checked="" type="checkbox"/> 8080 <input type="checkbox"/> 4-bit <input type="checkbox"/> _____ | |
| Backlight Type | <input checked="" type="checkbox"/> LED <input type="checkbox"/> Bottom <input checked="" type="checkbox"/> Single Side <input type="checkbox"/> Dual Side | |
| | <input type="checkbox"/> _____ <input type="checkbox"/> EL <input type="checkbox"/> CCFL | |
| Backlight Color | <input type="checkbox"/> Yellow-Green <input checked="" type="checkbox"/> White <input type="checkbox"/> Amber <input type="checkbox"/> Blue <input type="checkbox"/> Red <input type="checkbox"/> _____ | |
| EL/CCFL Driver type | <input type="checkbox"/> Build-in <input type="checkbox"/> External | |
| DC-DC Converter | <input checked="" type="checkbox"/> Build-in <input type="checkbox"/> External | |
| Operation Temperature | T _{OPL} = -20 T _{OPH} = +70 | • • |
| Storage Temperature | T _{STL} = -30 T _{STH} = +80 | • • |

2 Mechanical Diagram

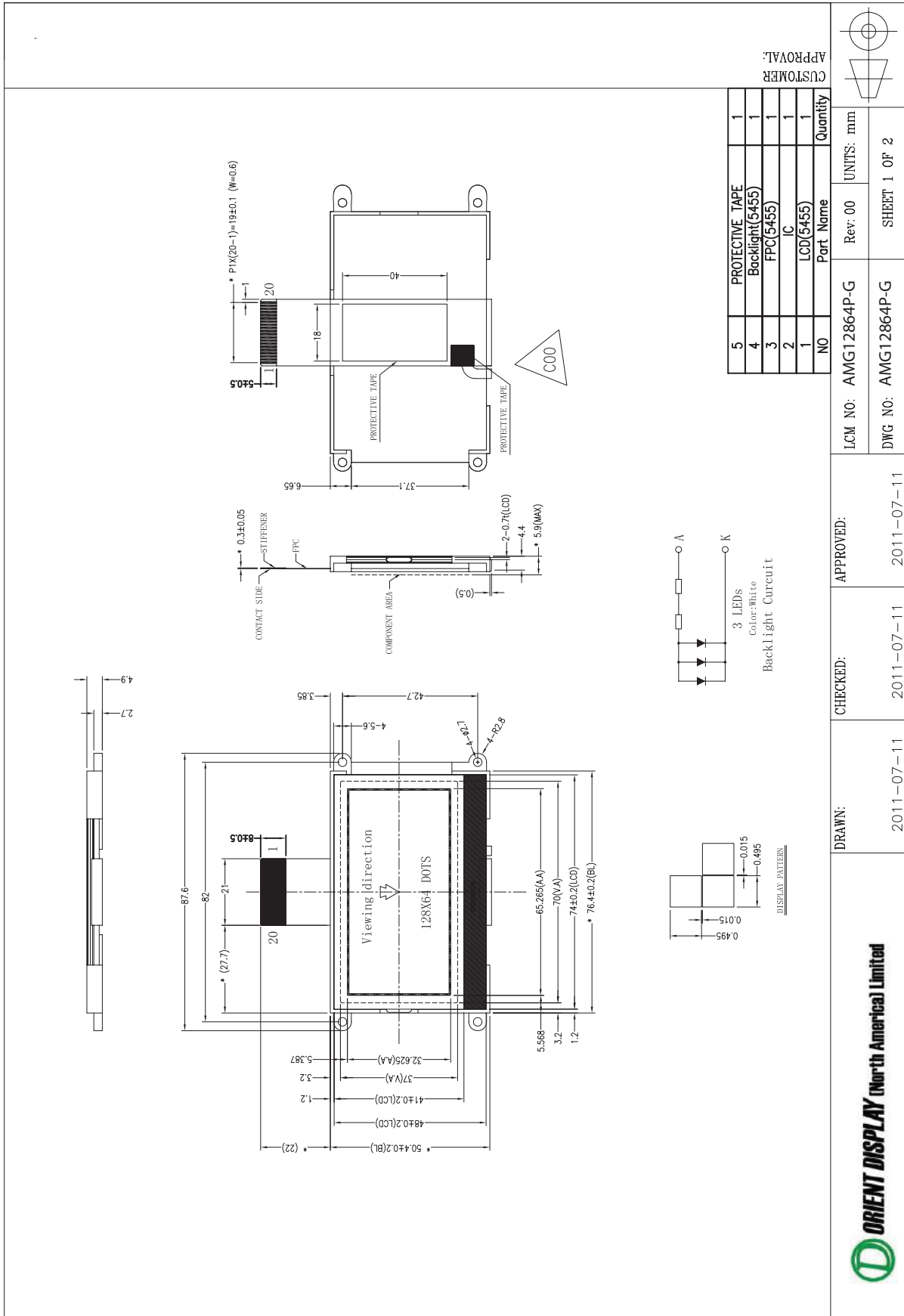

Block Diagram:

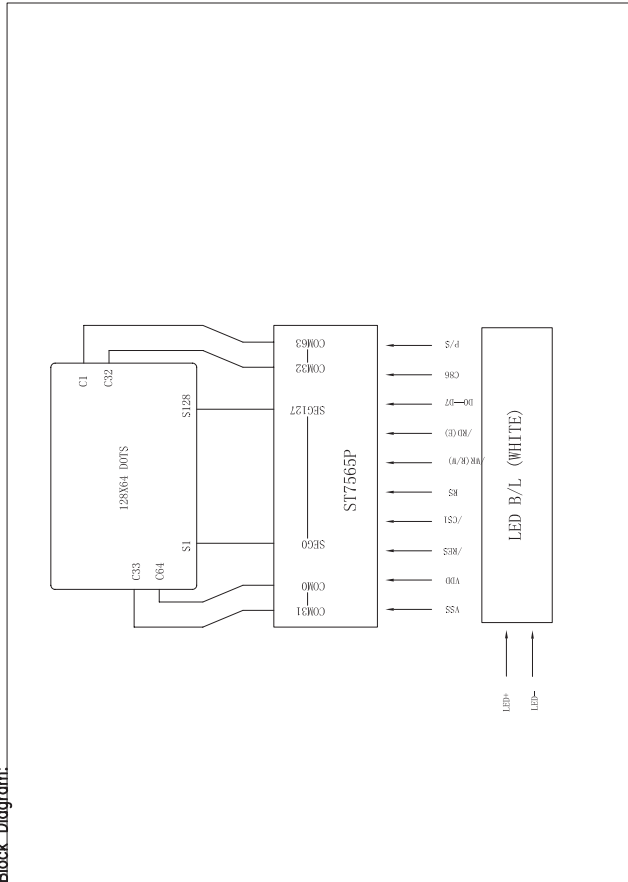

DISPLAY TYPE: STN/BLUE, Transmission, Negative
 VIEWING DIRECTION: 12:00
 DRIVER IC: ST7565P

LOGIC VOLTAGE: 3.0V(3.5V MAX)

LCD DRIVE VOLTAGE(Vlcd): 10.3V

DRIVING METHOD: 1/65 DUTY, 1/9 BIAS

Backlight:White

Iled=45mA Vled=5.0±0.3V

OPERATING TEMPERATURE: -20° ~ +70°C

STORAGE TEMPERATURE: -30° ~ +80°C

INTERFACE CONNECTOR: FPC

All UNMARKED TOLERANCE: ±0.3mm

PIN CONNECTION

| NO | SYMBOL |
|----|-----------|
| 1 | VSS |
| 2 | VDD |
| 3 | NC |
| 4 | /RES |
| 5 | /CS1 |
| 6 | RS |
| 7 | /WR (R/W) |
| 8 | /RD (E) |
| 9 | D0 |
| 10 | D1 |
| 11 | D2 |
| 12 | D3 |
| 13 | D4 |
| 14 | D5 |
| 15 | D6 |
| 16 | D7 |
| 17 | C86 |
| 18 | P/S |
| 19 | LED+ |
| 20 | LED- |



ORIENT DISPLAY (North America) Limited

DRAWN:

2011-07-11

CHECKED:

2011-07-11

APPROVED:

2011-07-11

Revision History:

LCM NO: AMG12864P-G

Rev: 00 UNITS: mm

DWG NO: AMG12864P-G

SHEET 2 OF 2

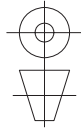

CUSTOMER APPROVAL:

3 I/O Terminal

3.1 Pin Description

| Pin NO. | Symbol | Function Description |
|---------|--------|--|
| 1 | VSS | Ground |
| 2 | VDD | Power supply. |
| 3 | NC | Not connect |
| 4 | /RES | When /RES is set to "L," the settings are initialized. The reset operation is performed by the /RES signal level. |
| 5 | /CS1 | This is the chip select signal. |
| 6 | RS | This is connect to the least significant bit of the normal and it determines whether the data bits are data or a RS = "H": Indicates that D0 to D7 are display data. RS = "L": Indicates that D0 to D7 are control data. |
| 7 | R/W | <ul style="list-style-type: none"> When connected to an 8080 MPU, this is active LOW. (R/W) This terminal connects to the 8080 MPU /WR signal. The signals on the data bus are latched at the rising edge of the /WR signal. When connected to a 6800 Series MPU: This is the read/write control signal input terminal. When R/W = "H": Read. When R/W = "L": Write. |
| 8 | E | <ul style="list-style-type: none"> When connected to a 6800 Series MPU, this is active HIGH. This is the 6800 Series MPU enable clock input terminal. |
| 9~16 | D0~D7 | This is an 8-bit bi-directional data bus that connects to an 8-bit or 16-bit standard MPU data bus. |
| 17 | C86 | This is the MPU interface switch terminal. C86 = "H": 6800 Series MPU interface. C86 = "L": 8080 MPU interface. |
| 18 | P/S | This is the parallel data input/serial data input switch terminal. P/S = "H": Parallel data input. P/S = "L": Serial data input. The following applies depending on the P/S status: When P/S = "L", D0 to D5 fixed "H". /RD (E) and /WR (R/W) are fixed to either "H" or "L". With serial data input, It is impossible read data from RAM . P/S Data/Command Data Read/Write Serial Clock "H" A0 D0 to D7 /RD, /WR X "L" A0 SI (D7) Write only SCL (D6) |
| 19 | LED+ | +5V |
| 20 | LED- | Ground |

3.2 Block Diagram and Application Circuit

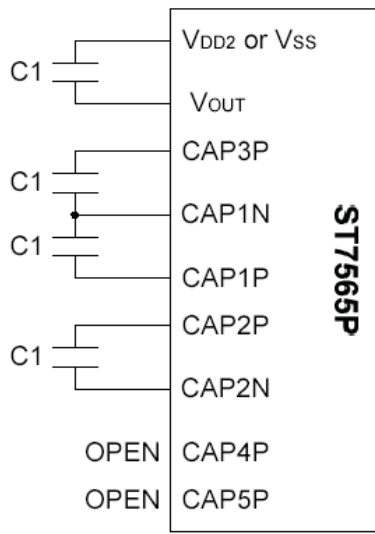

4x voltage booster circuit

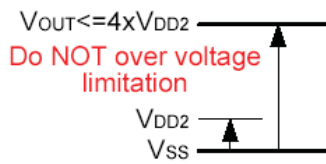

4x boost voltage relationship

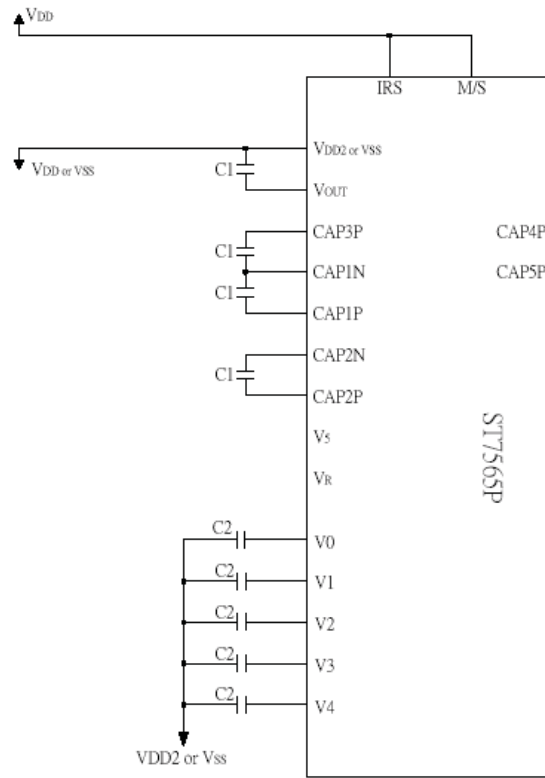

4 Electro-optical Specifications

4.1 Absolute Maximum Ratings

| No | Item | Symbol | Min. | Max. | Unit |
|----|-------------------------------|-------------------|------|------|------|
| 1 | Supply Voltage For Logic | $V_{DD} - V_{SS}$ | 0.3 | 3.6 | V |
| 2 | Supply Voltage For LCD Driver | V_{LCD} | 0.3 | 14.5 | V |
| 3 | Input Voltage | V_{IN} | 0.3 | 3.6 | V |

Note: Operating Temperature and Storage Temperature can be found in 1. *General Specifications*.

4.2 Optical Characteristics⁽¹⁾

| No | Item | Symbol | Condition | Min. | Typ. | Max. | Unit |
|----|----------------|-----------|---|------|------|------|------|
| 1 | Contrast Ratio | Cr | $T_a = 23 \pm 3^\circ\text{C}$ $V_{LCD} = \text{Typ.}^{(2)}$ | 8.4 | 9.08 | - | - |
| 2 | Response time | T_{ON} | $T_a = 23 \pm 3^\circ\text{C}$ | - | 223 | 330 | ms |
| 3 | Response time | T_{OFF} | $T_a = 23 \pm 3^\circ\text{C}$ | - | 102 | 200 | ms |
| 4 | Viewing Angle | 3H | $Cr = 2$ $T_a = 23 \pm 3^\circ\text{C}$ | 43 | 48 | - | Deg. |
| 5 | | 9H | | 45 | 49 | - | Deg. |
| 6 | | 6H | | 39 | 44 | - | Deg. |
| 7 | | 12H | | 26 | 31 | - | Deg. |

Note:

(1) See Appendix Definition of Optical Characteristics for detail.

(2) V_{LCD} can be found in 4.2 Electrical Characteristics *Supply Voltage for LCD Driver*

4.3 Electrical Characteristics

| No | Item | Symbol | Condition | Min. | Typ. | Max. | Unit |
|----|-------------------------------|-------------------|--------------------------|------|------|------|------|
| 1 | Supply Voltage for Logic | $V_{DD} - V_{SS}$ | - | 2.9 | 3.0 | 3.1 | V |
| 2 | Supply Voltage for LCD Driver | V_{LCD} | $T_a = 25^\circ\text{C}$ | 10.1 | 10.3 | 10.5 | V |
| 3 | Supply Current for Logic | I_{DD} | -.... | - | - | 1.0 | mA |
| 4 | Frame Frequency | f_M | $T_a = 25^\circ\text{C}$ | 17 | 20 | 24 | KHz |

| | | | | | | | |
|---|---------------------|----------|---|--------------|---|--------------|---|
| 5 | Input High Voltage | V_{IH} | - | $0.8 V_{DD}$ | - | V_{DD} | V |
| 6 | Input Low Voltage | V_{IL} | - | VSS | - | $0.2 V_{DD}$ | V |
| 7 | Output High Voltage | V_{OH} | - | $0.8 V_{DD}$ | - | V_{DD} | V |
| 8 | Output Low Voltage | V_{OL} | - | VSS | - | $0.2 V_{DD}$ | V |

| | | | | | | | |
|----|----------------------------------|-----------|---|-----|-----|-----|----|
| 9 | Supply Current for LED Backlight | I_{LED} | $V_{LED} = \text{Typ.}$ $T_a = 23 \pm 3^\circ\text{C}$ | - | 45 | - | mA |
| 10 | Supply Voltage for LED Backlight | V_{LED} | $I_{LED} = \text{Typ.}$ $T_a = 23 \pm 3^\circ\text{C}$ | 4.8 | 5.0 | 5.2 | V |

4.4 Timing Characteristics

System Bus Read/Write Characteristics 1 (For the 8080 Series MPU)

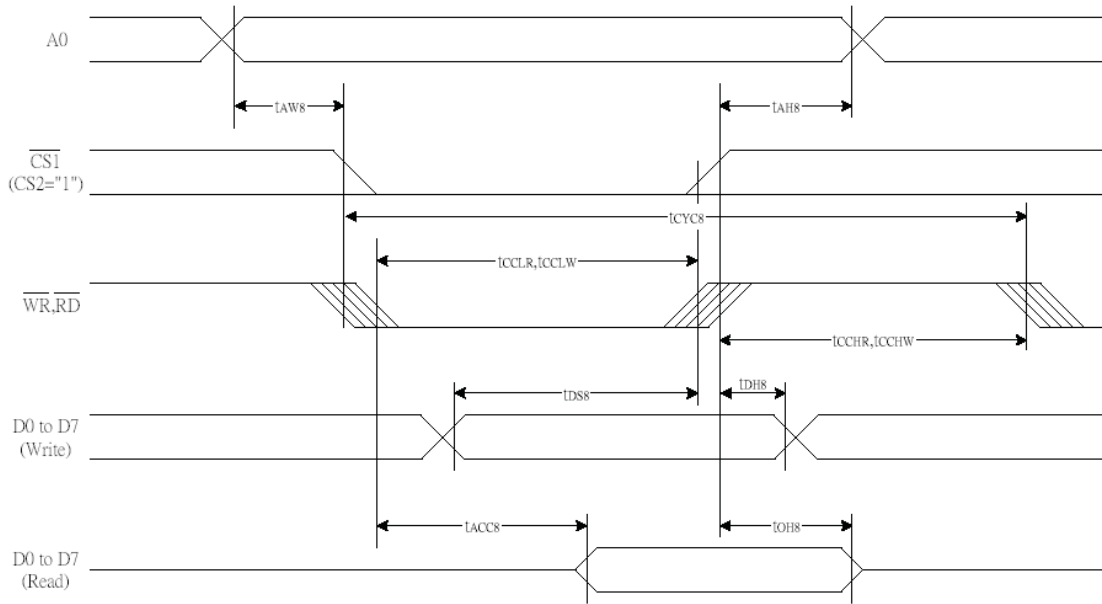

Figure 37

Table 24

(V_{DD} = 3.3V, T_a = -30 to 85°C)

| Item | Signal | Symbol | Condition | Rating | | Units |
|------------------------------|----------|-------------------|-------------|--------|------|-------|
| | | | | Min. | Max. | |
| Address hold time | A0 | t _{AH8} | | 0 | — | Ns |
| Address setup time | | t _{AW8} | | 0 | — | |
| System cycle time | | t _{CYC8} | | 240 | — | |
| Enable L pulse width (WRITE) | WR | t _{CCLW} | | 80 | — | |
| Enable H pulse width (WRITE) | | t _{CCHW} | | 80 | — | |
| Enable L pulse width (READ) | RD | t _{CCLR} | | 140 | — | |
| Enable H pulse width (READ) | | t _{CCHR} | | 80 | — | |
| WRITE Data setup time | D0 to D7 | t _{DS8} | | 40 | — | |
| WRITE Address hold time | | t _{DH8} | | 0 | — | |
| READ access time | | t _{ACC8} | CL = 100 pF | — | 70 | |
| READ Output disable time | | t _{OH8} | CL = 100 pF | 5 | 50 | |

(V_{DD} = 2.7V, Ta = -30 to 85°C)

| Item | Signal | Symbol | Condition | Rating | | Units |
|------------------------------|----------|-------------------|-------------|--------|------|-------|
| | | | | Min. | Max. | |
| Address hold time | A0 | t _{AH8} | | 0 | — | ns |
| Address setup time | | t _{AW8} | | 0 | — | |
| System cycle time | | t _{CYC8} | | 400 | — | |
| Enable L pulse width (WRITE) | WR | t _{CCLW} | | 220 | — | |
| Enable H pulse width (WRITE) | | t _{CCHW} | | 180 | — | |
| Enable L pulse width (READ) | RD | t _{CCLR} | | 220 | — | |
| Enable H pulse width (READ) | | t _{CCHR} | | 180 | — | |
| WRITE Data setup time | D0 to D7 | t _{DS8} | | 40 | — | |
| WRITE Address hold time | | t _{DH8} | | 0 | — | |
| READ access time | | t _{ACC8} | CL = 100 pF | — | 140 | |
| READ Output disable time | | t _{OH8} | CL = 100 pF | 10 | 100 | |

Table 26

(V_{DD} = 1.8V, Ta = -30 to 85°C)

| Item | Signal | Symbol | Condition | Rating | | Units |
|------------------------------|----------|-------------------|-------------|--------|------|-------|
| | | | | Min. | Max. | |
| Address hold time | A0 | t _{AH8} | | 0 | — | ns |
| Address setup time | | t _{AW8} | | 0 | — | |
| System cycle time | | t _{CYC8} | | 640 | — | |
| Enable L pulse width (WRITE) | WR | t _{CCLW} | | 360 | — | |
| Enable H pulse width (WRITE) | | t _{CCHW} | | 280 | — | |
| Enable L pulse width (READ) | RD | t _{CCLR} | | 360 | — | |
| Enable H pulse width (READ) | | t _{CCHR} | | 280 | — | |
| WRITE Data setup time | D0 to D7 | t _{DS8} | | 80 | — | |
| WRITE Address hold time | | t _{DH8} | | 0 | — | |
| READ access time | | t _{ACC8} | CL = 100 pF | — | 240 | |
| READ Output disable time | | t _{OH8} | CL = 100 pF | 10 | 200 | |

*1 The input signal rise time and fall time (t_r, t_f) is specified at 15 ns or less. When the system cycle time is extremely fast, (t_r + t_f) ≤ (t_{CYC8} - t_{CCLW} - t_{CCHW}) for (t_r + t_f) ≤ (t_{CYC8} - t_{CCLR} - t_{CCHR}) are specified.

*2 All timing is specified using 20% and 80% of V_{DD} as the reference.

*3 t_{CCLW} and t_{CCLR} are specified as the overlap between /CS1 being "L" (CS2 = "H") and /WR and /RD being at the "L" level.

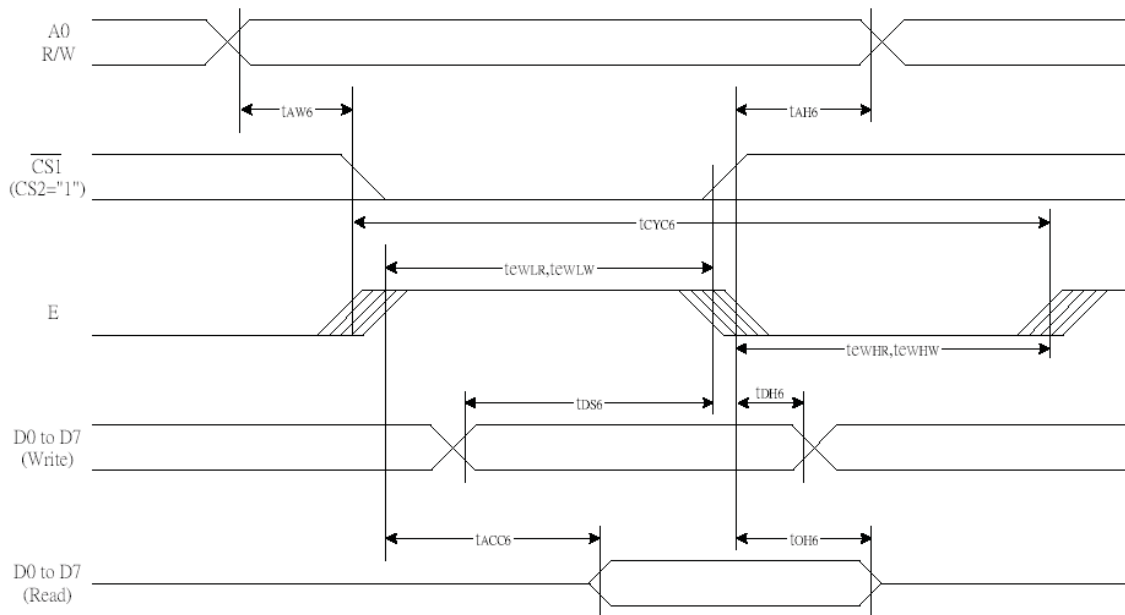

System Bus Read/Write Characteristics 2 (For the 6800 Series MPU)

Figure 38

Table 27

(V_{DD} = 3.3V, T_a = -30 to 85°C)

| Item | Signal | Symbol | Condition | Rating | | Units |
|------------------------------|----------|--------------------|-------------|--------|------|-------|
| | | | | Min. | Max. | |
| Address hold time | A0 | t _{AH6} | | 0 | — | ns |
| Address setup time | | t _{AW6} | | 0 | — | |
| System cycle time | | t _{CYC6} | | 240 | — | |
| Enable L pulse width (WRITE) | WR | t _{EWLW} | | 80 | — | |
| Enable H pulse width (WRITE) | | t _{EWHW} | | 80 | — | |
| Enable L pulse width (READ) | RD | t _{EWL R} | | 80 | — | |
| Enable H pulse width (READ) | | t _{EWH R} | | 140 | — | |
| WRITE Data setup time | D0 to D7 | t _{DS6} | | 40 | — | |
| WRITE Address hold time | | t _{DH6} | | 0 | — | |
| READ access time | | t _{ACC6} | CL = 100 pF | — | 70 | |
| READ Output disable time | | t _{OH6} | CL = 100 pF | 5 | 50 | |

(V_{DD} = 2.7V, T_a = -30 to 85°C)

| Item | Signal | Symbol | Condition | Rating | | Units |
|------------------------------|----------|-------------------|-------------|--------|------|-------|
| | | | | Min. | Max. | |
| Address hold time | A0 | t _{AH6} | | 0 | — | ns |
| Address setup time | | t _{AW6} | | 0 | — | |
| System cycle time | | t _{CYC6} | | 400 | — | |
| Enable L pulse width (WRITE) | WR | t _{EWLW} | | 220 | — | |
| Enable H pulse width (WRITE) | | t _{EWHW} | | 180 | — | |
| Enable L pulse width (READ) | RD | t _{EWLR} | | 220 | — | |
| Enable H pulse width (READ) | | t _{EWHR} | | 180 | — | |
| WRITE Data setup time | D0 to D7 | t _{DS6} | | 40 | — | |
| WRITE Address hold time | | t _{DH6} | | 0 | — | |
| READ access time | | t _{ACC6} | CL = 100 pF | — | 140 | |
| READ Output disable time | | t _{OH6} | CL = 100 pF | 10 | 100 | |

Table 29

(V_{DD} = 1.8V, T_a = -30 to 85°C)

| Item | Signal | Symbol | Condition | Rating | | Units |
|------------------------------|----------|-------------------|-------------|--------|------|-------|
| | | | | Min. | Max. | |
| Address hold time | A0 | t _{AH6} | | 0 | — | ns |
| Address setup time | | t _{AW6} | | 0 | — | |
| System cycle time | | t _{CYC6} | | 640 | — | |
| Enable L pulse width (WRITE) | WR | t _{EWLW} | | 360 | — | |
| Enable H pulse width (WRITE) | | t _{EWHW} | | 280 | — | |
| Enable L pulse width (READ) | RD | t _{EWLR} | | 360 | — | |
| Enable H pulse width (READ) | | t _{EWHR} | | 280 | — | |
| WRITE Data setup time | D0 to D7 | t _{DS6} | | 80 | — | |
| WRITE Address hold time | | t _{DH6} | | 0 | — | |
| READ access time | | t _{ACC6} | CL = 100 pF | — | 240 | |
| READ Output disable time | | t _{OH6} | CL = 100 pF | 10 | 200 | |

*1 The input signal rise time and fall time (t_r, t_f) is specified at 15 ns or less. When the system cycle time is extremely fast, (t_r + t_f) ≤ (t_{CYC6} - t_{EWLW} - t_{EWHW}) for (t_r + t_f) ≤ (t_{CYC6} - t_{EWLR} - t_{EWHR}) are specified.

*2 All timing is specified using 20% and 80% of V_{DD} as the reference.

*3 t_{EWLW} and t_{EWLR} are specified as the overlap between $\overline{CS1}$ being "L" (CS2 = "H") and E.

The Serial Interface

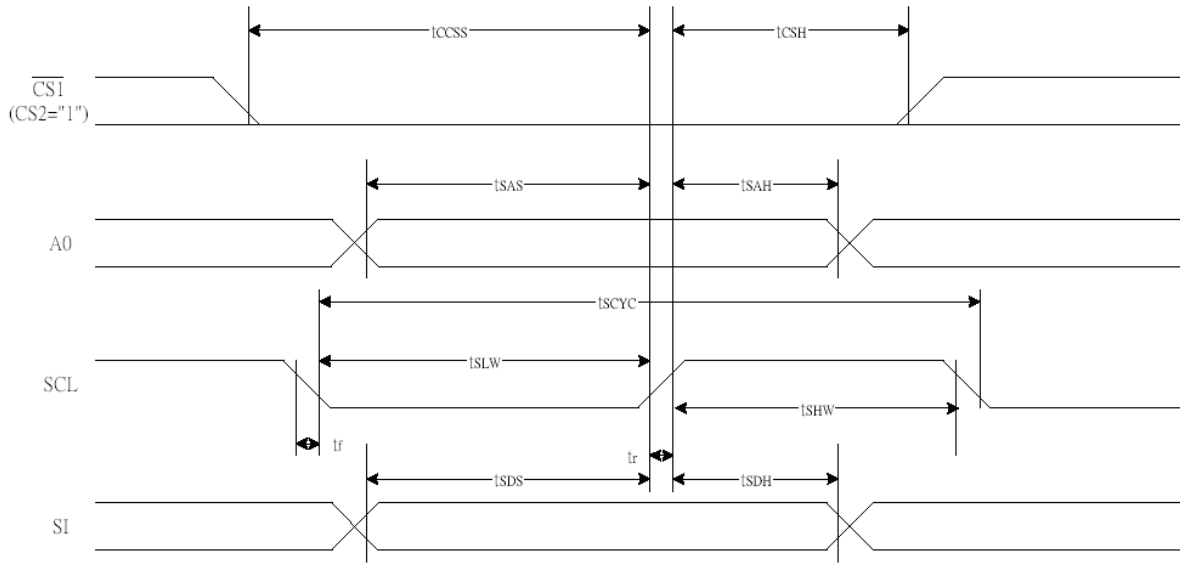

Figure 39

Table 30

(V_{DD} = 3.3V, T_a = -30 to 85°C)

| Item | Signal | Symbol | Condition | Rating | | Units |
|---------------------|--------|-------------------|-----------|--------|------|-------|
| | | | | Min. | Max. | |
| Serial Clock Period | SCL | T _{scyc} | | 50 | — | ns |
| SCL "H" pulse width | | T _{shw} | | 25 | — | |
| SCL "L" pulse width | | T _{slw} | | 25 | — | |
| Address setup time | A0 | T _{sas} | | 20 | — | |
| Address hold time | | T _{sah} | | 10 | — | |
| Data setup time | SI | T _{sds} | | 20 | — | |
| Data hold time | | T _{sdh} | | 10 | — | |
| CS-SCL time | CS | T _{css} | | 20 | — | |
| CS-SCL time | | T _{csh} | | 40 | — | |

Table 31

(V_{DD} = 2.7V, T_a = -30 to 85°C)

| Item | Signal | Symbol | Condition | Rating | | Units |
|---------------------|--------|-------------------|-----------|--------|------|-------|
| | | | | Min. | Max. | |
| Serial Clock Period | SCL | T _{scyc} | | 100 | — | ns |
| SCL "H" pulse width | | T _{shw} | | 50 | — | |
| SCL "L" pulse width | | T _{slw} | | 50 | — | |
| Address setup time | A0 | T _{sas} | | 30 | — | |
| Address hold time | | T _{sah} | | 20 | — | |
| Data setup time | SI | T _{sds} | | 30 | — | |
| Data hold time | | T _{sdh} | | 20 | — | |
| CS-SCL time | CS | T _{css} | | 30 | — | |
| CS-SCL time | | T _{csh} | | 60 | — | |

(V_{DD} = 1.8V, T_a = -30 to 85°C)

| Item | Signal | Symbol | Condition | Rating | | Units |
|---------------------|--------|-------------------|-----------|--------|------|-------|
| | | | | Min. | Max. | |
| Serial Clock Period | SCL | T _{SCYC} | | 200 | — | ns |
| SCL "H" pulse width | | T _{SHW} | | 80 | — | |
| SCL "L" pulse width | | T _{SLW} | | 80 | — | |
| Address setup time | A0 | T _{SAS} | | 60 | — | |
| Address hold time | | T _{SAH} | | 30 | — | |
| Data setup time | SI | T _{SDS} | | 60 | — | |
| Data hold time | | T _{SDH} | | 30 | — | |
| CS-SCL time | CS | T _{CSS} | | 40 | — | |
| CS-SCL time | | T _{CSH} | | 100 | — | |

*1 The input signal rise and fall time (t_r, t_f) are specified at 15 ns or less.

*2 All timing is specified using 20% and 80% of V_{DD} as the standard.

5 Programming

5.1 Instruction Table

| Command | Command Code | | | | | | | | | | Function | |
|---|--------------|-----|-----|------------|----|-------------------------|----|----------------------------------|----------------|----|----------|---|
| | A0 | /RD | /WR | D7 | D6 | D5 | D4 | D3 | D2 | D1 | | D0 |
| (1) Display ON/OFF | 0 | 1 | 0 | 1 | 0 | 1 | 0 | 1 | 1 | 1 | 0 | 1 |
| (2) Display start line set | 0 | 1 | 0 | 0 | 1 | Display start address | | | | | | |
| (3) Page address set | 0 | 1 | 0 | 1 | 0 | 1 | 1 | Page address | | | | |
| (4) Column address set upper bit | 0 | 1 | 0 | 0 | 0 | 0 | 1 | Most significant column address | | | | Sets the most significant 4 bits of the display RAM column address. Sets the least significant 4 bits of the display RAM column address. |
| Column address set lower bit | 0 | 1 | 0 | 0 | 0 | 0 | 0 | Least significant column address | | | | |
| (5) Status read | 0 | 0 | 1 | Status | | | | 0 | 0 | 0 | 0 | |
| (6) Display data write | 1 | 1 | 0 | Write data | | | | | | | | |
| (7) Display data read | 1 | 0 | 1 | Read data | | | | | | | | |
| (8) ADC select | 0 | 1 | 0 | 1 | 0 | 1 | 0 | 0 | 0 | 0 | 0 | 1 |
| (9) Display normal/reverse | 0 | 1 | 0 | 1 | 0 | 1 | 0 | 0 | 1 | 1 | 0 | 1 |
| (10) Display all points ON/OFF | 0 | 1 | 0 | 1 | 0 | 1 | 0 | 0 | 1 | 0 | 0 | 1 |
| (11) LCD bias set | 0 | 1 | 0 | 1 | 0 | 1 | 0 | 0 | 0 | 1 | 0 | 1 |
| (12) Read/modify/write | 0 | 1 | 0 | 1 | 1 | 1 | 0 | 0 | 0 | 0 | 0 | 0 |
| (13) End | 0 | 1 | 0 | 1 | 1 | 1 | 0 | 1 | 1 | 1 | 0 | |
| (14) Reset | 0 | 1 | 0 | 1 | 1 | 1 | 0 | 0 | 0 | 1 | 0 | |
| (15) Common output mode select | 0 | 1 | 0 | 1 | 1 | 0 | 0 | 0 | * | * | * | 1 |
| (16) Power control set | 0 | 1 | 0 | 0 | 0 | 1 | 0 | 1 | Operating mode | | | |
| (17) Vo voltage regulator internal resistor ratio set | 0 | 1 | 0 | 0 | 0 | 1 | 0 | 0 | Resistor ratio | | | |
| (18) Electronic volume mode set | 0 | 1 | 0 | 1 | 0 | 0 | 0 | 0 | 0 | 0 | 0 | 1 |
| Electronic volume register set | | | | 0 | 0 | Electronic volume value | | | | | | |
| (19) Static indicator ON/OFF | 0 | 1 | 0 | 1 | 0 | 1 | 0 | 1 | 1 | 0 | 0 | 1 |
| Static indicator register set | | | | 0 | 0 | 0 | 0 | 0 | 0 | 0 | 0 | 0 |
| (20) Booster ratio set | 0 | 1 | 0 | 1 | 1 | 1 | 1 | 1 | 0 | 0 | 0 | 0 |
| (21) Power saver | | | | | | | | | | | | |
| (22) NOP | 0 | 1 | 0 | 1 | 1 | 1 | 0 | 0 | 0 | 1 | 1 | |
| (23) Test | 0 | 1 | 0 | 1 | 1 | 1 | 1 | * | * | * | * | |

5.2 Display Data RAM

Relationship between display pattern and Display Data RAM show as below:

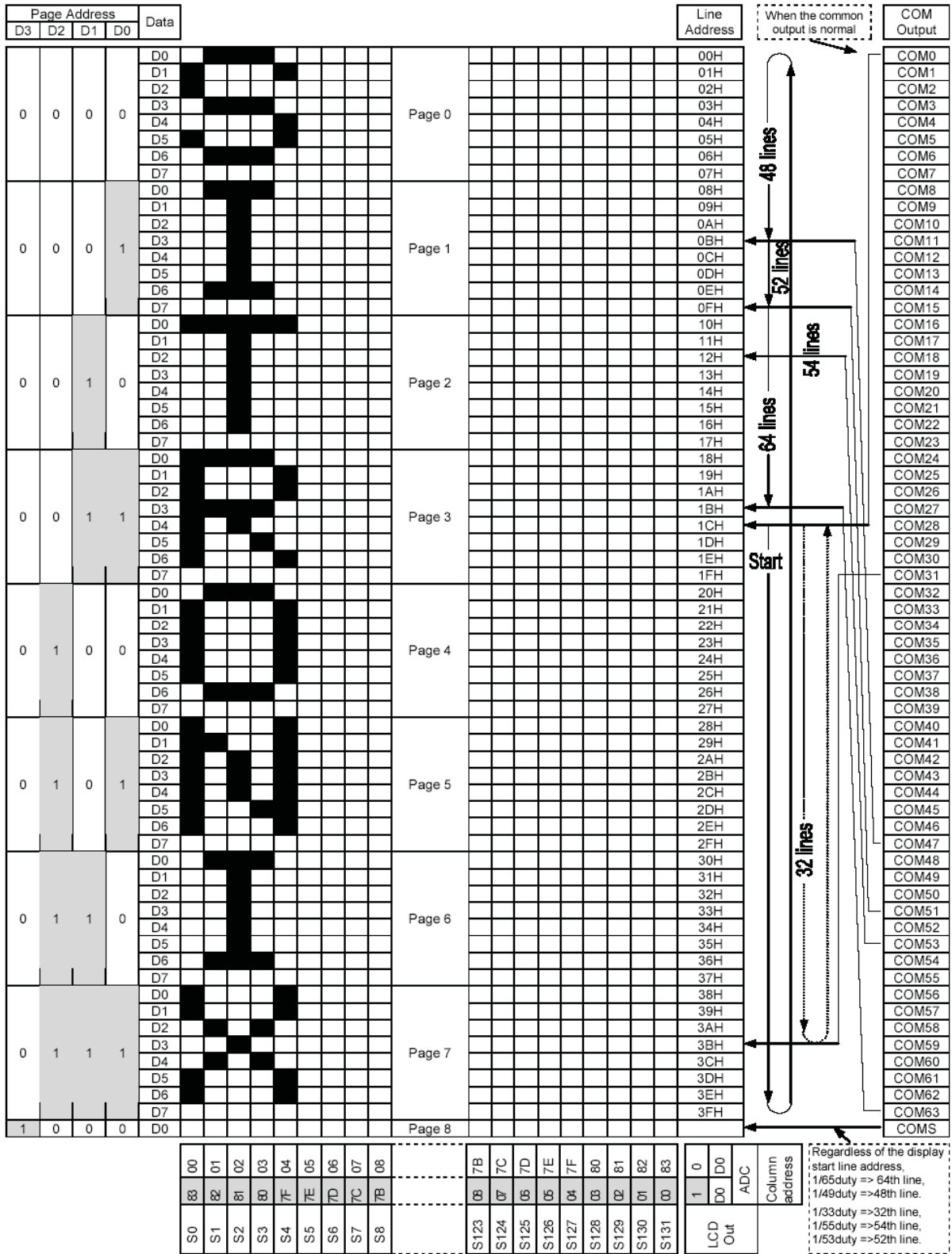

Appendix

1 Packing Method

Method 1

ESD Bag + Product Box + Plastic Bag + Carton

4. Packing Method

1. Quantity

| QUANTITY | UNIT |
|----------|---------------|
| 1 | PCS / ESD Bag |
| 108 | PCS / Box |
| 2 | Box / Carton |
| 216 | PCS / Carton |

2. Material

| Material | Size (LXWXH) mm |
|-------------|-----------------|
| ESD Bag | |
| Product Box | |
| Carton | |

3. Label

PRODUCT ID:
 PART NO:
 QUANTITY:
 GROSS WEIGHT:
 MEASUREMENTS:

Note: see table 1. Quantity for detail.

Method 2

ESD Tray + Plastic Bag + Carton

4. Packing Method

1. Quantity

| QUANTITY | UNIT |
|----------|---------------|
| | PCS / Tray |
| | Tray / Carton |
| | PCS / Carton |

2. Material

| Material | Size (LXWXH) mm |
|----------|-----------------|
| ESD Tray | |
| Carton | |

3. Label

PRODUCT ID:
 PART NO:
 QUANTITY:
 GROSS WEIGHT:
 MEASUREMENTS:

Note: see table 1. Quantity for detail.

Note:

2 Definitions of Optical Characteristic

2.1 Contrast Ratio Test

A) Contrast ratio is calculated by the following formula when the output voltage is obtained from the electro-optical test system.

B) Test Condition: Accord to the LCD's driving method and operating voltage (V_{LCD}).

C) Formula:

$$\text{Contrast Ratio (Positive type)} = \frac{\text{Photometer output voltage when non-select waveform is applying}}{\text{Photometer output voltage when select waveform is applying}}$$

$$\text{Contrast Ratio (Negative type)} = \frac{\text{Photometer output voltage when select waveform is applying}}{\text{Photometer output voltage when non-select waveform is applying}}$$

D) Test system:

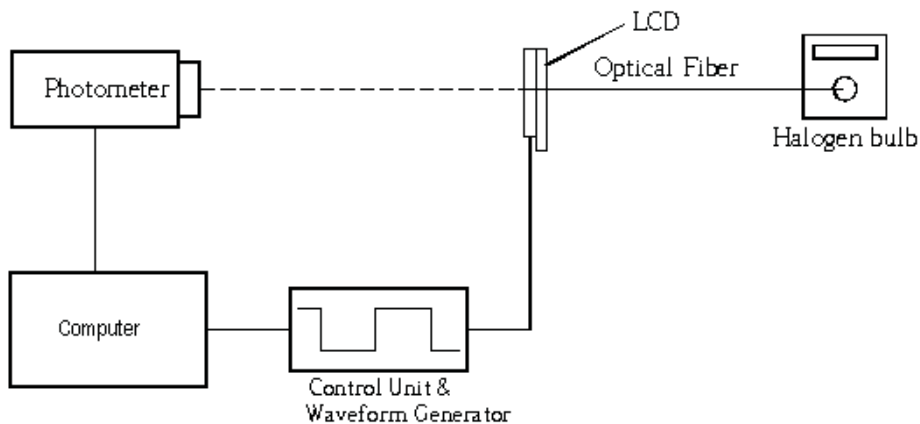

2.2 Response time

2.2.1 Positive type

- A) Rise time is defined as the time required for the transmission to change from 90% to 10%.
- B) Fall time is defined as the time required for the transmission to change from 10% to 90%.
- C) On time is defined as the time required for the transmission to change from 100% to 10%.
- D) Off time is defined as the time required for the transmission to change from 0% to 90%.

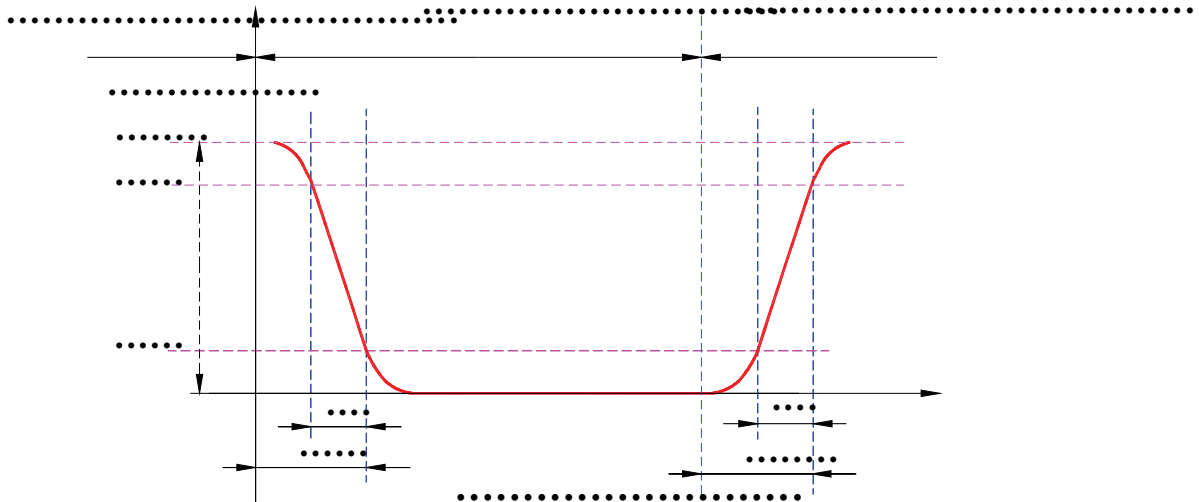

2.2.1 Negative type

- A) Rise time is defined as the time required for the transmission to change from 10% to 90%.
- B) Fall time is defined as the time required for the transmission to change from 90% to 10%.
- C) On time is defined as the time required for the transmission to change from 0% to 90%.
- D) Off time is defined as the time required for the transmission to change from 100% to 10%.

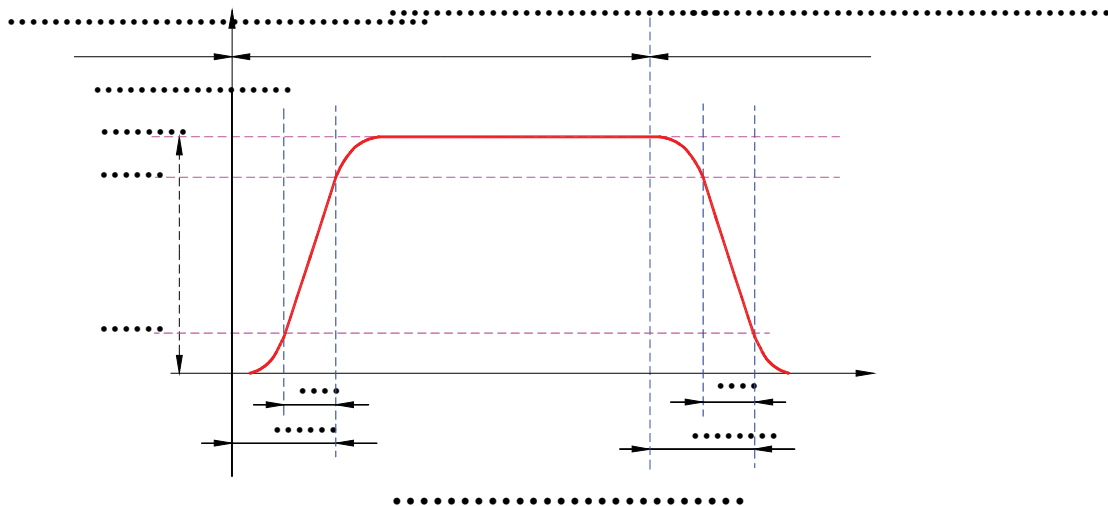

2.3 Viewing Angle

A) Viewing angle is definition

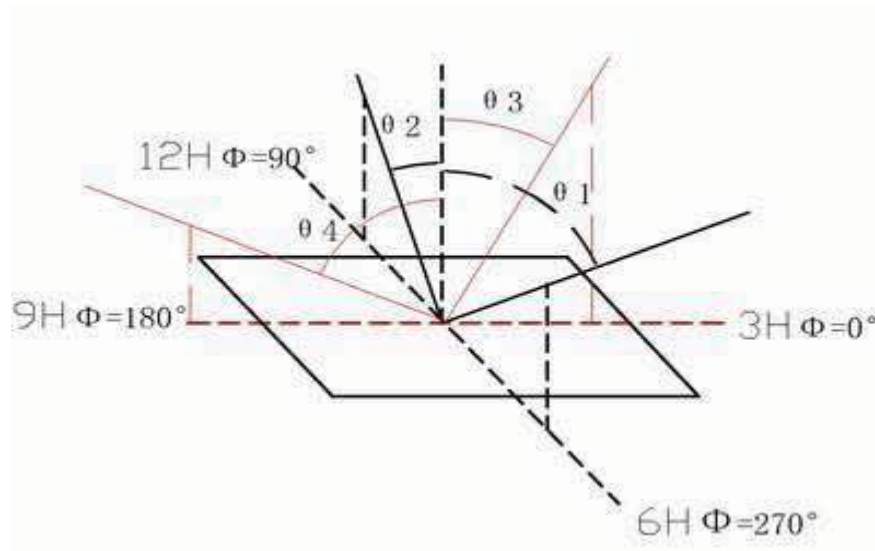

B) System Block Diagram

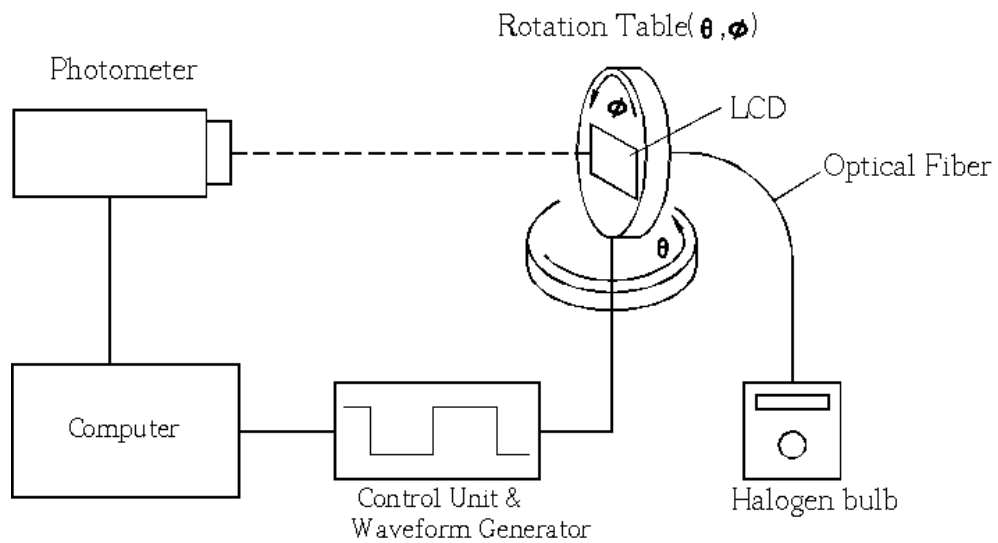

3 Quality Units

3.1 Visual and Technological Inspection

- Visual inspection must be performed with naked eye on display.
 - Distance between observer and display should be about 30 cm.
 - Perform inspection at OFF state and ON state
 - Ambient lighting should be 1000 lux
 - Transmissive, transreflective and negative type specimens should be inspected in backlight
- (i) Inspecting method:

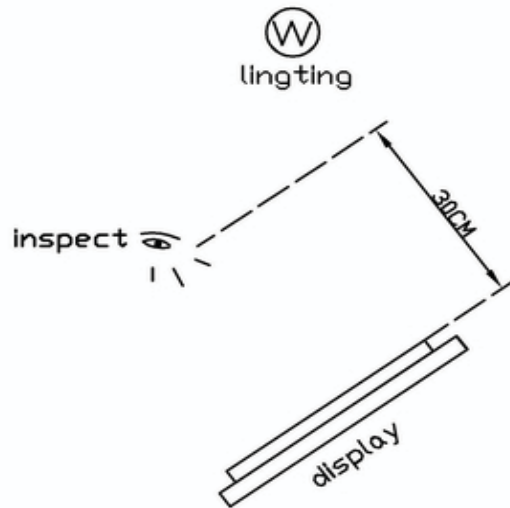

(ii) Definition of area:

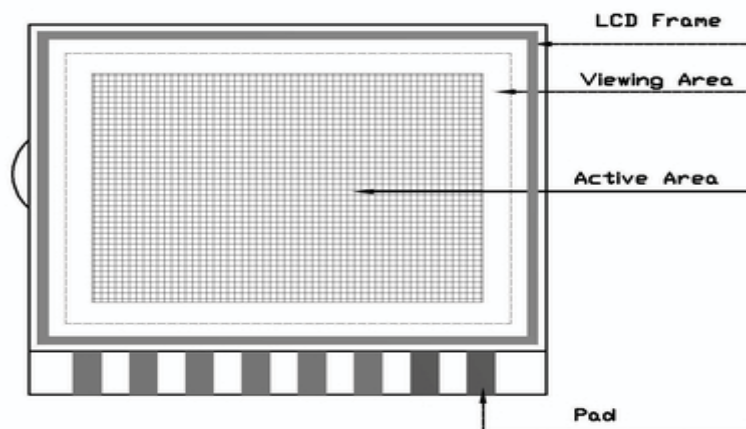

Note: The drawing is a general sketch map only. If want to see the product outline detail, please see the product outline drawing.

3.2 Visual Inspection Standard:

Table1

(Unit: mm)

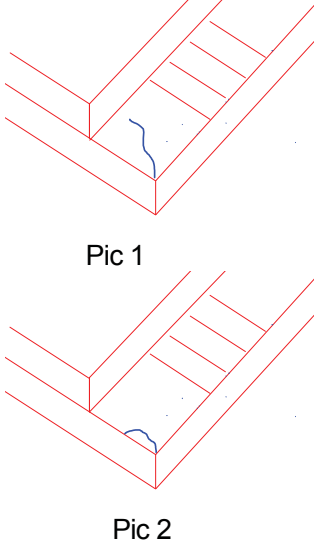
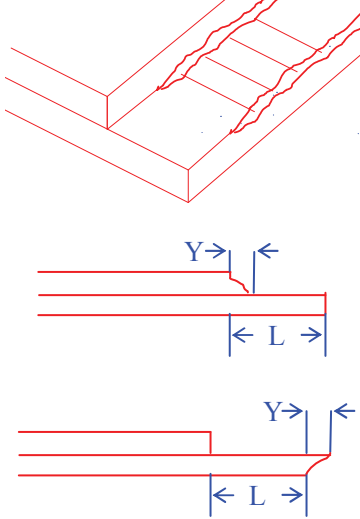
| No | Defect Item | | | Criterion | |
|------|--|----------|------------|--|--------------------------|
| | Defect describe | Position | classify | Section | Acceptable Number(N)(*3) |
| 1 | Liquid Crystal Leakage | | | | Not acceptable |
| 2 | Bubble in Liquid Crystal | | | | Not acceptable |
| 3 | Rainbow | | Slight *1 | | Acceptable |
| | | | Obvious *2 | | Not acceptable |
| 4 | ITO Glass Crackle  | | Slight | Pic 1: Enter into the glass | Not acceptable |
| | | | Slight | Pic 2: not Enter into the glass | 2 |
| 5 *4 | ITO Glass Protrusion:  | | Slight | 1: smaller glass edge: Y: $\leq 1/6$, X ignore, Z: \leq 2: larger glass edge: no influence upon no influence upon outline dimension assemble, display function | 1 |
| 6 *4 | Chipped Glass: | pad Edge | Slight | X: ≤ 1.5 , Y: $\leq 1/3L$, Z: \leq or chip don't touch one third of Pad width. | 2 |

| | | | | | |
|-----------|--|----------------------------------|--------|---|------------|
| | | Non-Pad Edge | Slight | $X \leq 2, Y \leq 1, Z \leq t, Y$ can't enter into active area and can't touch the sealant | 2 |
| | | Corner | Slight | $X \leq 1.5, Y \leq 1.5, Z \leq t$ | 2 |
| 7 | Black/White Spots (Include LCD and Backlight): Virtual Diameter: $\phi = (a+b) / 2 \text{ mm}$ | Circular Type | Slight | $\phi \leq 0.1$ | Acceptable |
| | | | | $0.10 < \phi \leq 0.2$ | 2 |
| | | | | $0.2 < \phi \leq 0.25$ | 1 |
| | | Linear Type | Slight | $B \leq 0.05 \quad A \leq 2$ | Acceptable |
| | | | | $0.05 < B \leq 0.1 \quad A \leq 2$ | 2 |
| $B > 0.1$ | | According to the spot's standard | | | |
| 8 | Polarizer Bubble | | | $\phi \leq 0.2$ | Acceptable |
| | | | | $0.2 < \phi \leq 0.3$ | 2 |
| | | | | $0.3 < \phi \leq 0.5$ | 1 |
| Note | 1. Slight rainbow: rainbow outside of Viewing Area, or concolorous rainbow inside of ViewingArea but don't go beyond the limited sample which affirmed by purchaser. 2. Obvious rainbow: double color rainbow in Viewing area and go beyond the limited sample which affirmed by purchaser. 3. Acceptable Number(N) is the defects number in the LCD that will be defined according to the defects distributing density. In this table,the acceptable number is $\leq 1/1(\text{cm})^2$. If purchaser has different suggest, please discuss with GW. | | | | |

3.3 Display Inspection Standard:

Table2

(Unit: mm)

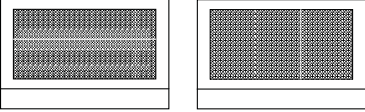
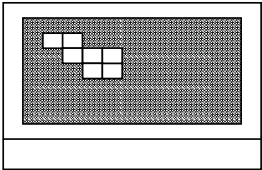
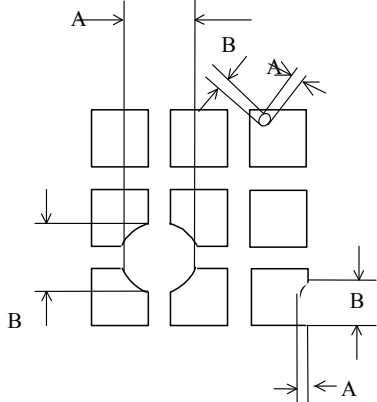
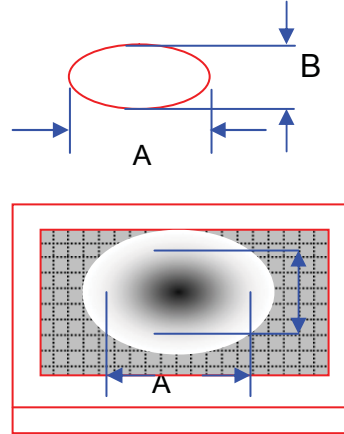
| No | Defect Item | Criterion | |
|-----------------------|--|--|----------------------------------|
| | | Section | Acceptable Number(N) (*1) |
| 1 | Non display | | Not acceptable |
| 2 | Display missing  | | Not acceptable |
| 3 | Short Circuit | | Not acceptable |
| 4 | Abnormal display  | | Not acceptable |
| 5 | Pin Hole & Gap in displaying segment or Dot Matrix:  Virtual Diameter: • $\bar{a} = \frac{a+b}{2}$ • mm • | • • $\bar{0.1}$ | Acceptable |
| | | 0.1 • • • $\bar{0.2}$ • | 2 |
| | | 0.2 • • • $\bar{0.25}$ • | 1 |
| | | • $\bar{>0.25}$ | Not acceptable |
| 6 | Display Black/White Spots  • $\bar{a} = \frac{A+B}{2}$ mm | The spot's dimension and color don't alter with the voltage alteration | |
| | | • • $\bar{0.10}$ | acceptable |
| | | 0.10 < • • $\bar{0.2}$ | 3 |
| | | 0.2 < • • $\bar{0.25}$ | 1 |
| | | • $\bar{>0.25}$ | Not acceptable |
| | | The spot's dimension and color alter with the voltage alteration | |
| | | • • $\bar{0.3}$ | acceptable |
| | | 0.3 < • • $\bar{0.5}$ | 3 |
| 0.5 < • • $\bar{0.8}$ | 1 | | |
| • $\bar{>0.8}$ | Not acceptable | | |
| 7 | Display Black/White lines | The Line's dimension and color don't alter with the voltage alteration | |
| | | B • $\bar{0.05}$ A • $\bar{2}$ | acceptable |
| | | 0.05 < B • $\bar{0.1}$ A • $\bar{2}$ | 3 |
| | | B > 0.1 | According to the spot's standard |

| | | | |
|------|---|--|----------------------------------|
| | | The Line's dimension and color alter with the voltage alteration | |
| | | $B \cdot 0.07 \quad A \cdot 5$ | acceptable |
| | | $0.07 < B \cdot 0.15 \quad A \cdot 5$ | 3 |
| | | $0.15 < B \cdot 0.3 \quad A \cdot 5$ | 1 |
| | | $B > 0.3$ | According to the spot's standard |
| 8 | The current overflow | | Not acceptable |
| Note | 1. when the width value of Segment or Dot Matrix is less than 3.0 mm, no default is acceptable 2. No more than 5 defaults are acceptable in 1cm^2 area. | | |

4 Reliability-TEST

4.1. Standard Specifications for Reliability

4.1-1 Test method

There should be no existing conspicuous failure of functions and appearance in LCD after the following tests.

| NO | Item | Description |
|----|----------------------------|---|
| 1 | Low Temperature Operating | The sample should be allowed to stand at $(-20 \pm 2)^\circ\text{C}$ for 96 Hours under driving condition. |
| 2 | High Temperature Operating | The sample should be allowed to stand at $(+70 \pm 2)^\circ\text{C}$ for 96 Hours under driving condition. |
| 3 | Low Temperature Storage | The sample should be allowed to stand at $(-30 \pm 3)^\circ\text{C}$ for 96 Hours under no-load condition, and then returning it to normal temperature condition, and allowing it stand for 24 hours |
| 4 | High Temperature Storage | The sample should be allowed to stand at $(+80 \pm 2)^\circ\text{C}$ for 96Hours under no-load condition, and then returning it to normal temperature condition, and allowing it stand for 24 hours |
| 5 | Moisture resistance | The sample should be allowed to stand at $(40 \pm 2)^\circ\text{C}$; $(95 \pm 2)\% \text{RH}$ for 96Hours under no-load condition excluding the polarizer, then taking it out and drying it at normal temperature, and allowing it stand for 24 hours |
| 6 | Thermal Shock Resistance | The sample should be allowed to stand the following 5 cycles of operation: T_{STL}^* for 30 minutes \rightarrow normal temperature for 5 minutes $\rightarrow T_{\text{STH}}^*$ for 30 minutes \rightarrow normal temperature for 5 minutes, as one cycle, then taking it out and drying it at normal temperature, and allowing it stand for 24 hours |

Note:

T_{STL} : Lowest Storage Operation Temperature.

T_{STH} : Lowest Storage Temperature.

4.1-2 Testing Conditions and Inspection Criteria:

For the final test, the testing sample must be stored at room temperature for 24 hours, after the tests listed above; Standard specifications for Reliability have been executed in order to ensure stability.

| NO | Item | Inspection Criteria |
|----|---------------------|---|
| 1 | Current Consumption | The current consumption should be under double of initial test. |
| 2 | Contrast | The contrast must be larger than half of initial test. |
| 3 | Appearance | Appearance defects should not happen. |

4.2 Life Time:

Functions, performance, appearance, etc. shall be free from remarkable deterioration within 50,000 hours under ordinary operating and storage conditions room temperature ($25\pm 10^{\circ}\text{C}$), normal humidity ($45\pm 20\%\text{RH}$), and in area not exposed to direct sunlight.