



Doc.No.: AFY320240A0-3.5N6NTM-R

REV : A0

PAGE : 1/18

EFFECTIVE DATE : 2013-08-07

SPECIFICATION OF LCD MODULE

MODULE NO: AFY320240A0-3.5N6NTM-R

Customer Approval:

Accept

Reject

FUTURE FOCUS	SIGNATURE	DATE
PREPARED BY		
CHECKED BY		
APPROVED BY		



Doc.No.: AFY320240A0-3.5N6NTM-R

REV : A0

PAGE : 2/18

EFFECTIVE DATE : 2013-08-07

Sample Version	Doc. Version	DATE	DESCRIPTION	CHECKED BY
0001	A0	2013-08-07	First Release	



Doc.No.: AFY320240A0-3.5N6NTM-R

REV : A0

PAGE : 3/18

EFFECTIVE DATE : 2013-08-07

CONTENTS

List	Description	Page No.
	NUMBER SYSTEM INTRODUCTION	4
1	GENERAL SPECIFICATIONS	4
2	BLOCK DIAGRAM	5
3	DIMENSIONAL OUTLINE	6
4	PIN DESCRIPTION	7
5	ELECTRICAL CHARACTERISTICS	8
6	INPUT SIGNAL TIMING	12
7	OPTICAL CHARACTERISTICS	15
8	RELIABILITY	17
9	SPECIFICATION OF QUALITY ASSURANCE	17
10	GENERAL PRECAUTION	17
11	LIMITED WARRANTY	17
12	PACKAGE	18

NUMBER SYSTEM INTRODUCTION:

AFY320240A0-3.5N6NTM-R:

AF: Orient Display TFT;

Y: JAZZ TFT;

320240: Length * width pixel;

A0: Product Version;

3.5: Diagonal Dimension;

N: LCD Mode (N: TN; I: IPS; V: VA)

6: Viewing Direction (6-> 6:00; 12->12:00; Unavailable for IPS and VA);

N: Temperature Range (N: Normal; W: Wide);

T: Polarizer (T:Transmissive; F:Transflective);

M: Luminance (N: Normal <300 nit; M: Middle >=300 & <600 nit;

H: High >=600 nit);

R: TP Option (R: Resistive TP; C: Capacitive TP; N: Without TP);

1. GENERAL SPECIFICATIONS

ITEM	SPECIFICATION	UNIT
OUTLINE DIMENSIONS	76.9 (W) X63.9 (H) X4.45(D)	mm
DISPLAY SIZE	3.5	inch
DOT PITCH	0.219mmX0.219mm	mm
NUMBER OF DOTS	320* (RGB) *240	-
DRIVER IC	HX8238D	-
LCD TYPE	TFT(16.7M) TRANSMISSIVE	-
INTERFACE	RGB 24BITS	
BACKLIGHT TYPE	LED White	-
VIEWING DIRECTION	6 O'clock	-
GRAY SCALE INVERSION DIRECTION	6 O'clock	

*See attached drawing for details.

2. BLOCK DIAGRAM

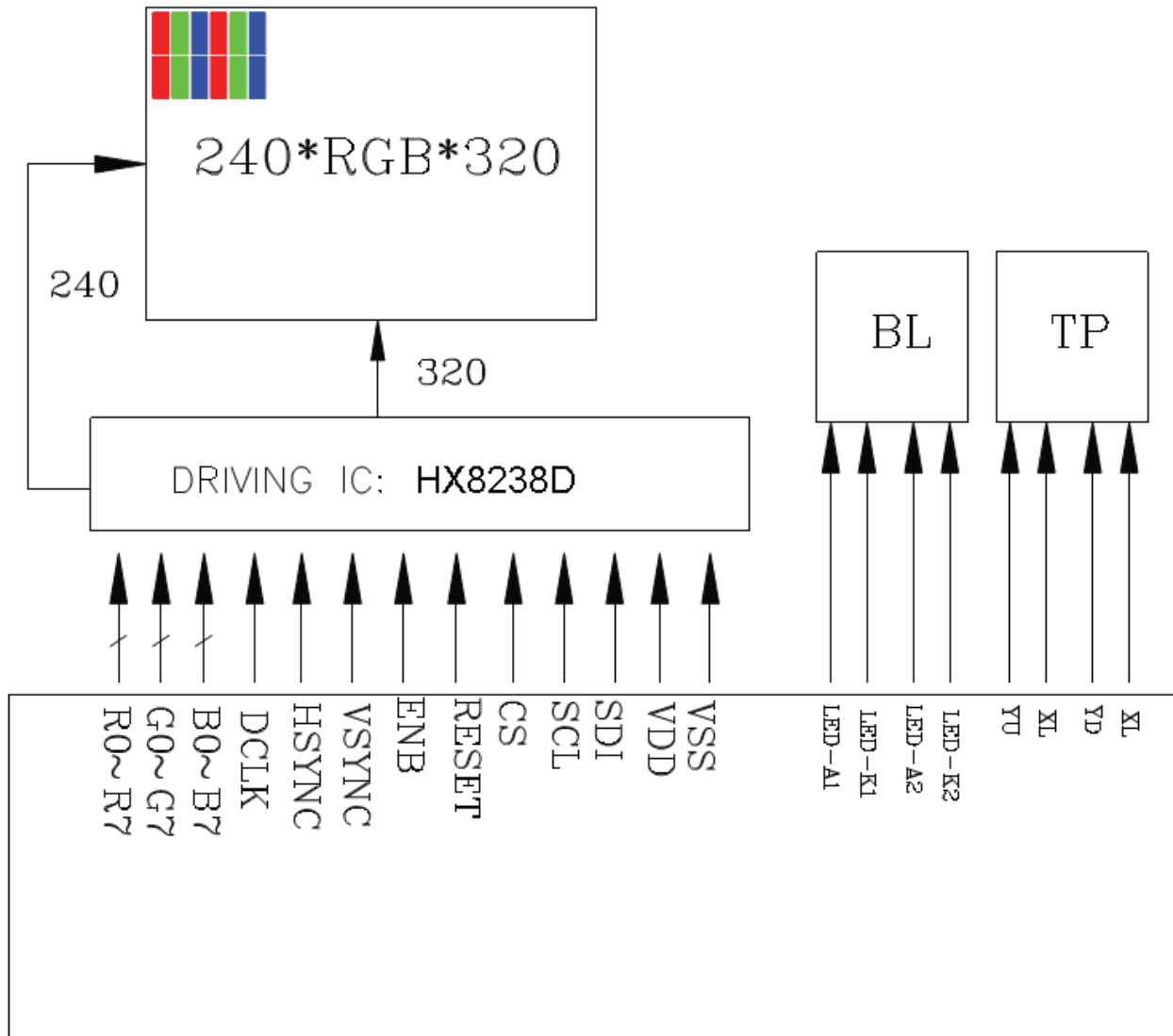

3. DIMENSIONAL OUTLINE

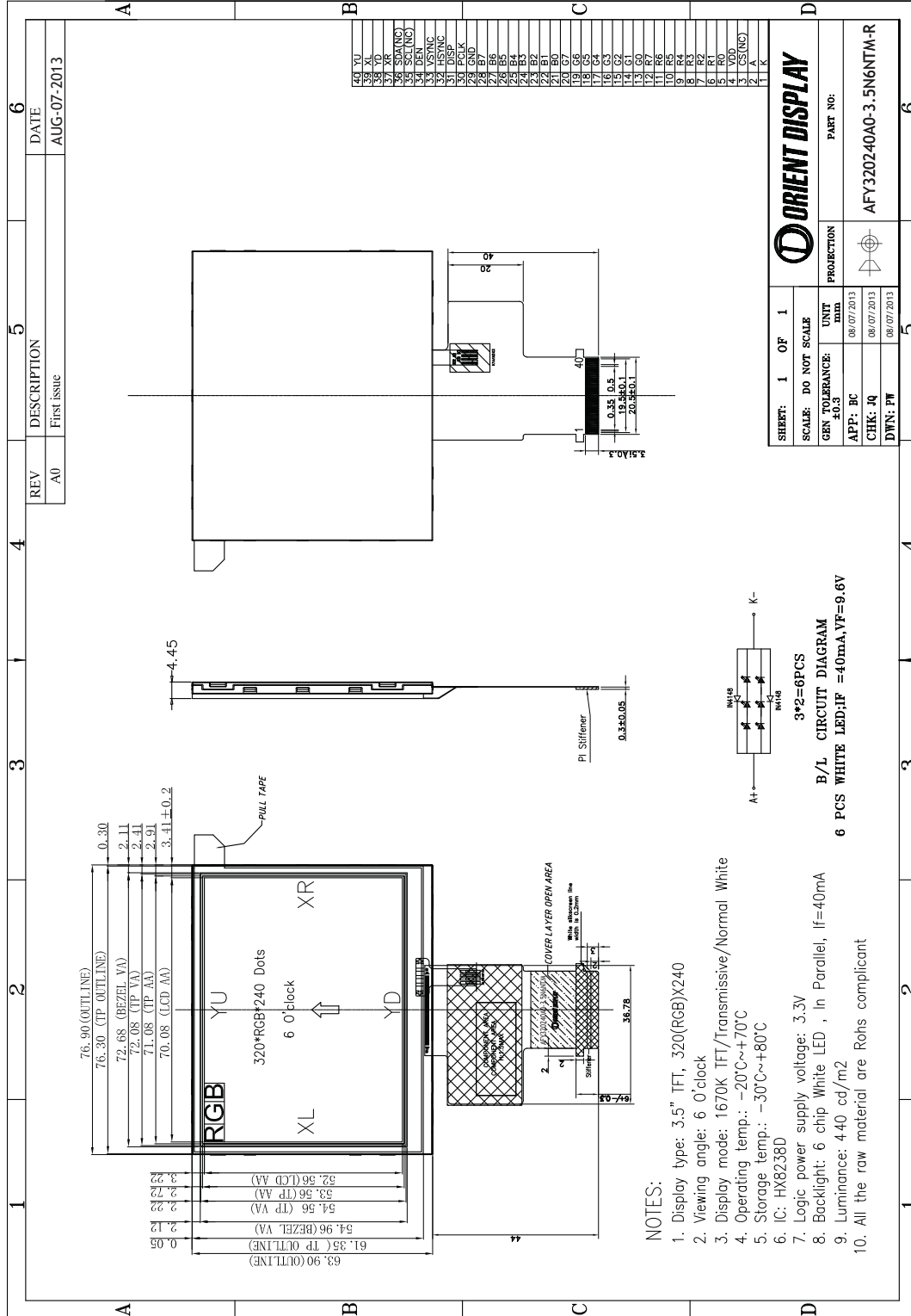

49	YU
38	XU
35	YD
34	XD
32	YU(NG)
33	XU(NG)
34	YD(NG)
34	XD(NG)
33	YU(NC)
33	YD(NC)
31	YU(NC)
30	YU(NC)
29	YU(NC)
28	YU(NC)
27	YU(NC)
26	YU(NC)
25	YU(NC)
24	YU(NC)
23	YU(NC)
22	YU(NC)
21	YU(NC)
20	YU(NC)
19	YU(NC)
18	YU(NC)
17	YU(NC)
16	YU(NC)
15	YU(NC)
14	YU(NC)
13	YU(NC)
12	YU(NC)
11	YU(NC)
10	YU(NC)
9	YU(NC)
8	YU(NC)
7	YU(NC)
6	YU(NC)
5	YU(NC)
4	YU(NC)
3	YU(NC)
2	YU(NC)
1	YU(NC)

ORIENT DISPLAY

SHEET: 1 OF 1

SCALE: DO NOT SCALE

GEN TOLERANCE: ±0.3

APP: BC

CHK: JQ

DWN: PW

PROJECTION

UNIT: MM

DATE: 08/07/2013

PART NO: AFY320240A0-3.5N6NTM-R

- NOTES:
1. Display type: 3.5" TFT, 320(RGB)X240
 2. Viewing angle: 6 0'clock
 3. Display mode: 1670K TFT/Transmissive/Normal White
 4. Operating temp.: -20°C~+70°C
 5. Storage temp.: -30°C~+80°C
 6. IC: HX8238D
 7. Logic power supply voltage: 3.3V
 8. Backlight: 6 chip White LED , In Parallel, If=40mA
 9. Luminance: 440 cd/m2
 10. All the raw material are Rohs compliant

4. PIN DESCRIPTION

NO.	PIN NAME	Type	Description
1	LED-	P	Power supply for LED (Cathode)
2	LED+	P	Power supply for LED (Anode)
3	CS (NC)	-	No connection
4	VDD	P	Power voltage
5	R0	I	RED data signal(LSB)
6	R1	I	RED data signal
7	R2	I	RED data signal
8	R3	I	RED data signal
9	R4	I	RED data signal
10	R5	I	RED data signal
11	R6	I	RED data signal
12	R7	I	RED data signal(MSB)
13	G0	I	GREEN data signal(LSB)
14	G1	I	GREEN data signal
15	G2	I	GREEN data signal
16	G3	I	GREEN data signal
17	G4	I	GREEN data signal
18	G5	I	GREEN data signal
19	G6	I	GREEN data signal
20	G7	I	GREEN data signal(MSB)
21	B0	I	BLUE data signal(LSB)
22	B1	I	BLUE data signal
23	B2	I	BLUE data signal
24	B3	I	BLUE data signal
25	B4	I	BLUE data signal
26	B5	I	BLUE data signal
27	B6	I	BLUE data signal
28	B7	I	BLUE data signal(MSB)
29	GND	I	Ground(0V)
30	DOTCLK	I	Pixel clock signal
31	DISP	I	Display on/ off
32	HSYNC	I	Horizontal synchronizing signal
33	VSNC	I	Vertical synchronizing signal
34	DE	I	Data enable
35	SCL (NC)	-	No connection
36	SDA (NC)	-	No connection
37	XR	-	TP: X right
38	YD	-	TP: Y bottom
39	XL	-	TP: X left
40	YU	-	TP: Y top

Note: I: input, O: output, P: Power

5. ELECTRICAL CHARACTERISTICS

5.1 Absolute Maximum Ratings

Item	Symbol	Values		Unit	Remark
		Min	Max		
Power Supply for Pump	VCC	-0.3	3.6	V	
Operating temperature range	To	-20	70	Degree C	
Storage temperature range	Ts	-30	80	Degree C	
Logic input voltage range	VI	-0.3	VCC+0.3	V	
Logic input voltage range	VO	-0.3	VCC+0.3	V	

Note: Stresses beyond those given in the Absolute Maximum Rating table may cause operational errors or damage to the device. For normal operational conditions see AC/DC Electrical Characteristics

5.2 DC Characteristics

Item	Symbol	Values			Unit	Conditions
		Min	Typ	Max		
Low Level Input Voltage	Vil	GND	-	0.3xVCC	v	
High Level Input Voltage	Vih	0.7xVCC	-	VCC	uA	
High Level Output Voltage	Voh	VCC-0.4	-	VCC	ohm	
Low Level Output Voltage	Vol	GND	-	GND+0.4	uA	
Power Supply	VCC	2.5	2.8	3.3	V	
Input Leakage Current	Iil			±1.0	uA	
Pull High/Low Resistor	Rp	-	100K	-	ohm	

5.3 DC Backlight Unit

Item	Symbol	Min	Typ	Max	Unit	Remark
Average luminous Intensity	Iv		440		cd/m2	IF=40mA
Chromaticity Coordinates	X	0.234	0.284	0.334		IF=40mA
	Y	0.273	0.323	0.373		IF=40mA
Forward Voltage	VF		9.6	10.2	V	IF=40mA
Reverse Current	IR			50	μA	VR=10V, 1LED
Luminous Tolerance	IV-M	80			%	(MIN/MAX)×100
Power Dissipation	Pd		384		mW	
Reverse Voltage	VR		5		V	

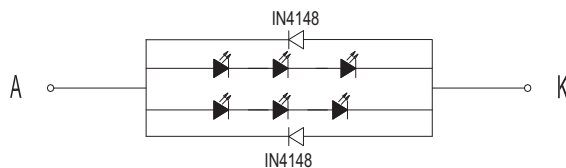

B/L CIRCUIT DIAGRAM

6 PCS WHITE LED; IF = 40mA, VF = 9.6V

5.4 DC Touch Panel Unit

Item	Symbol	Min	Typ	Max	Unit	Remark
Transparency	-	80	-	-	%	JIS K-7105
Hardness Of Surface	-	-	3	-	H	150gf 45°
FPC Peeling Strength	-	5		-	N	Upward 90°
FPC Bending	-	-	3	-	cycle	R=1.0, 90°
Input Force	20	-		80	gf	-
Rated Voltage	V touch			3	V	DC
X-axis Resistance	Rx	300		900		FPC PIN
X-axis Resistance	Ry	150		500		
Linearity	-	-	±1.5	±2.0	%	-
Chattering	-	-	-	10	ms	-
Insulation Resistance	Ri	20	-	-	MΩ	-

5.4 Power up sequence

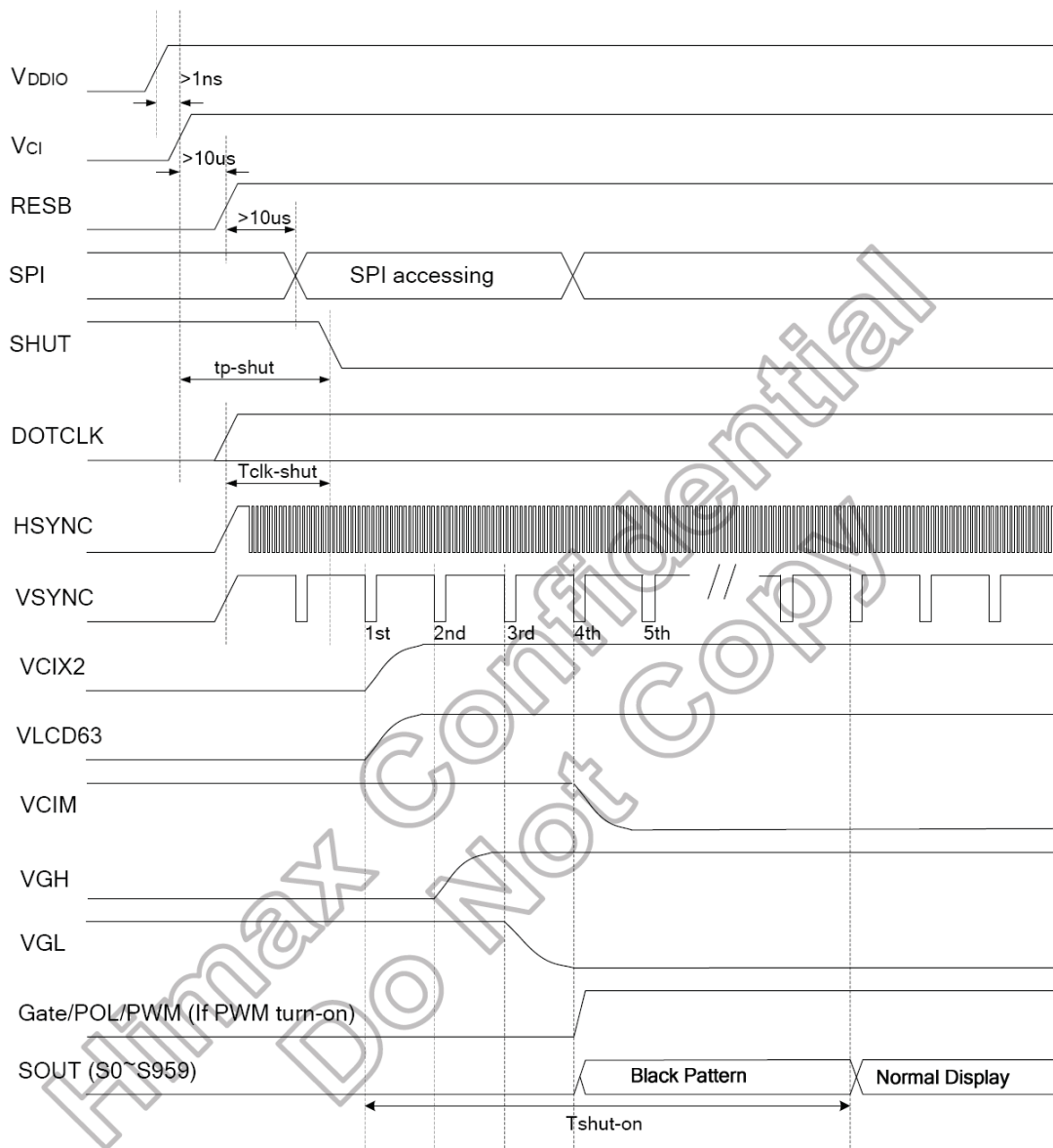

Figure 12. 10 Power Up Sequence

Characteristics	Symbol	Spec.			Unit
		Min.	Typ.	Max.	
VDDD / VDDIO on to falling edge of SHUT	t_{p-shut}	1	-	-	μs
DOTCLK	$t_{clk-shut}$	1	-	-	clk
Falling edge of SHUT to display start	$t_{shut-on}$	-	-	14	frame
- 1 line: 408 clk - 1 frame: 262 line - DOTCLK = 6.5MHz		-	166	232.4	ms

Note: It is necessary to input DOTCLK before the falling edge of SHUT.

Display starts at 10th falling edge of VSTNC after the falling edge of SHUT.

5.5 Power down sequence

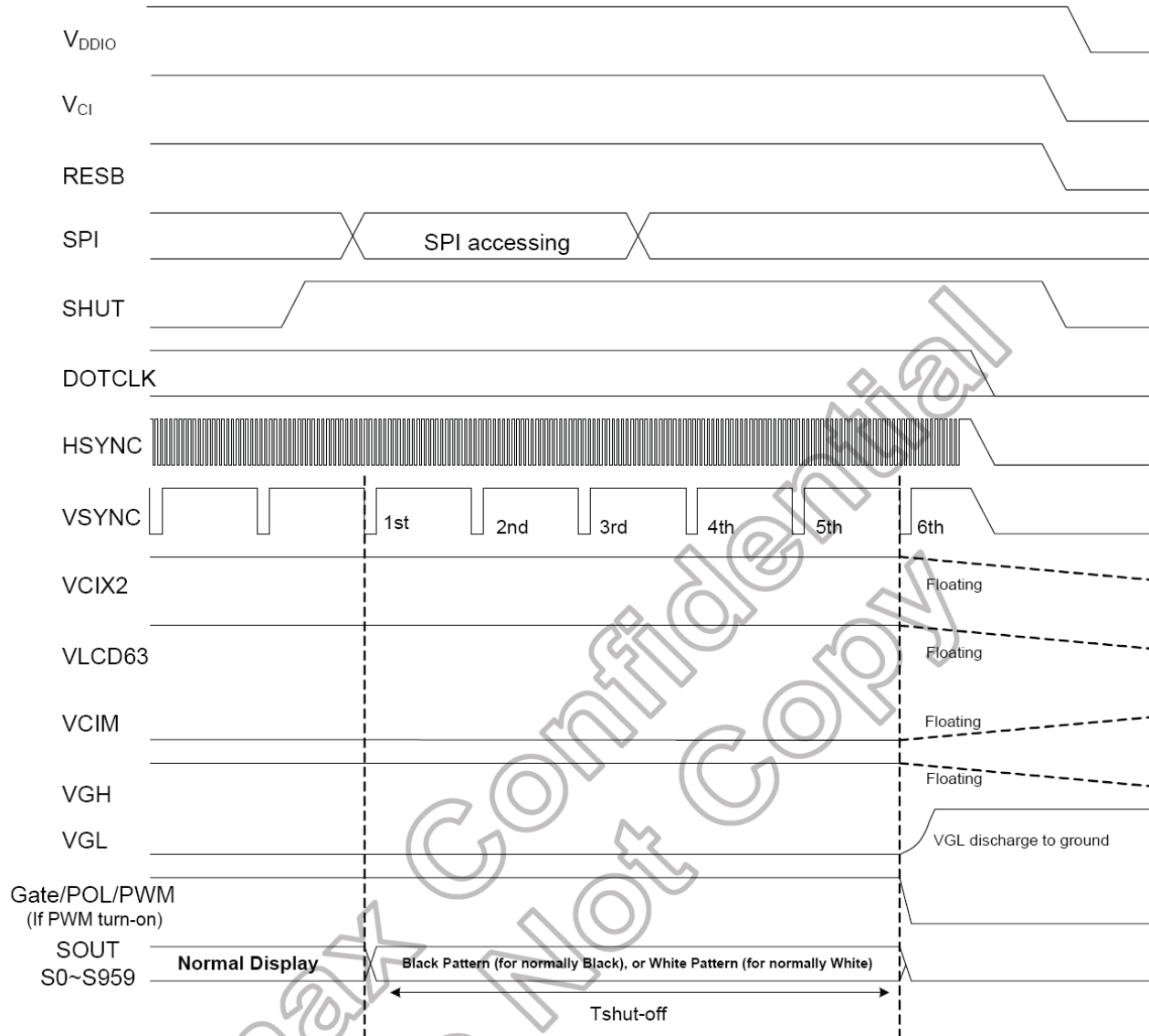

Figure 12. 11 Power Down Sequence

Characteristics	Symbol	Spec.			Unit
		Min.	Typ.	Max.	
Rising edge of SHUT to display off	tshut-off	2	-	-	frame
- 1 line: 408 clk - 1 frame: 262 line - DOTCLK = 6.5MHz		33.4	-	-	ms

Note: DOTCLK must be maintained at least 2 frames after the rising edge of SHUT.

Display become off at the 2nd falling edge of VSTNC after the falling edge of SHUT.

If RESET signal is necessary for power down, provide it after the 2-frames-cycle of the SHUT period.

6. INPUT SIGNAL TIMING

6.1 | Pixel Timing

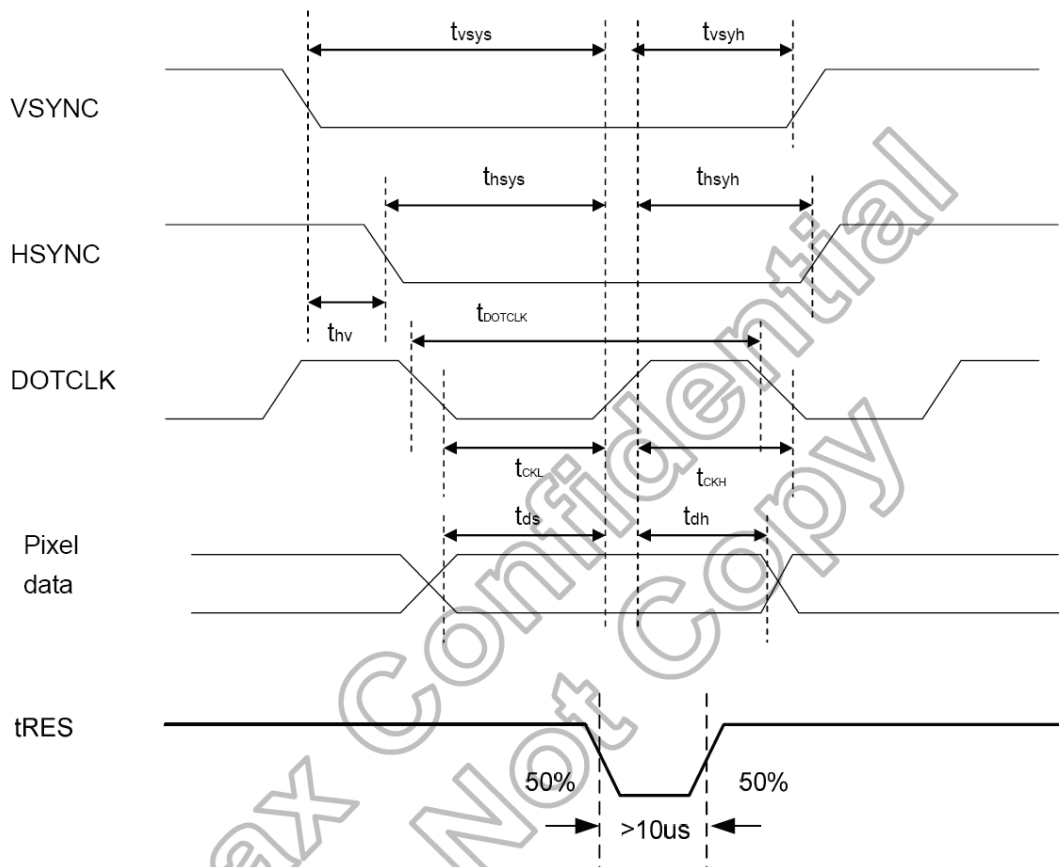
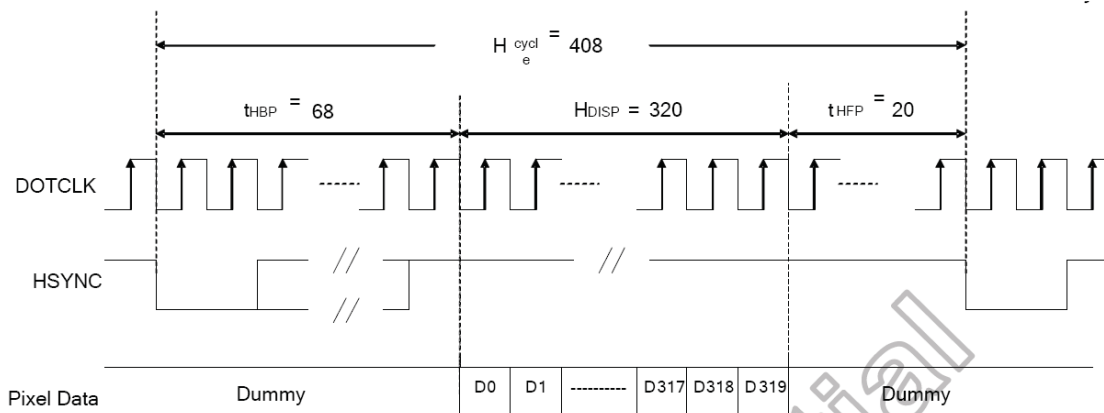

Figure 12. 1 Pixel Timing

Characteristics	Symbol	Min.		Typ.		Max.		Unit
		24 bit	8 bit	24 bit	8 bit	24 bit	8 bit	
DOTCLK Frequency	f _{DOTCLK}	-	-	6.5	19.5	10	30	MHz
DOTCLK Period	t _{DOTCLK}	100	33.3	154	51.3	-	-	ns
Vertical Sync Setup Time	t _{vsys}	20	10	-	-	-	-	ns
Vertical Sync Hold Time	t _{vsh}	20	10	-	-	-	-	ns
Horizontal Sync Setup Time	t _{hsys}	20	10	-	-	-	-	ns
Horizontal Sync Hold Time	t _{hsh}	20	10	-	-	-	-	ns
Phase difference of Sync Signal Falling Edge	t _{hv}	1		-		240		t _{DOTCLK}
DOTCLK Low Period	t _{ckl}	50	15	-	-	-	-	ns
DOTCLK High Period	t _{ckh}	50	15	-	-	-	-	ns
Data Setup Time	t _{ds}	12	10	-	-	-	-	ns
Data hold Time	t _{dh}	12	10	-	-	-	-	ns
Reset pulse width	t _{RES}	10		-		-		μs

Note: External clock source must be provided to DOTCLK pin of HX8238-D. The driver will not operate if absent of the clocking signal.

6.2 Data Transaction Timing in Parallel RGB (24 bit) Interface (SYNC Mode)



(a) Horizontal Data Transaction Timing

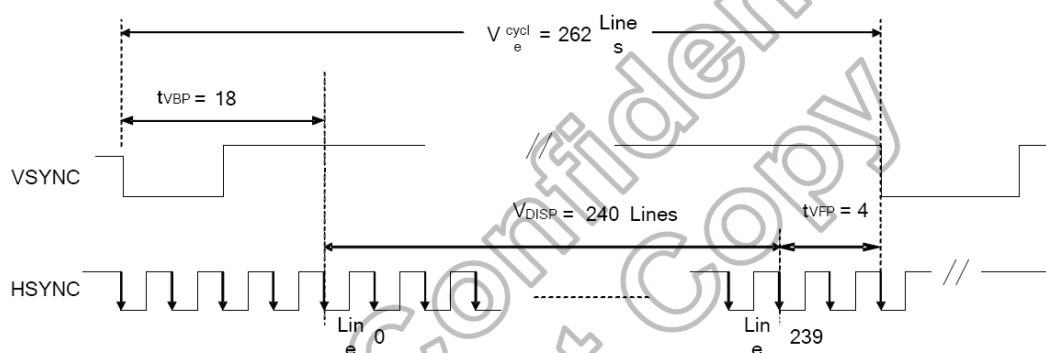

(b) Vertical Data Transaction Timing

Figure 12. 2 Data Transaction Timing in Parallel RGB (24 bit) Interface (SYNC Mode)

Characteristics	Symbol	Min.		Typ.		Max.		Unit
		24 bit	8 bit	24 bit	8 bit	24 bit	8 bit	
DOTCLK Frequency	f _{DOTCLK}	-	-	6.5	19.5	10	30	MHz
DOTCLK Period	t _{DOTCLK}	100	33.3	154	51.3	-	-	ns
Horizontal Frequency (Line)	f _H	-	-	14.9		22.35		KHz
Vertical Frequency (Refresh)	f _V	-	-	60		90		Hz
Horizontal Back Porch	t _{HBP}	-	-	68	204	-	-	t _{DOTCLK}
Horizontal Front Porch	t _{HFP}	-	-	20	60	-	-	t _{DOTCLK}
Horizontal Data Start Point	t _{HBP}	-	-	68	204	-	-	t _{DOTCLK}
Horizontal Blanking Period	t _{HBP} + t _{HFP}	-	-	88	264	-	-	t _{DOTCLK}
Horizontal Display Area	H _{DISP}	-	-	320	960	-	-	t _{DOTCLK}
Horizontal Cycle	H _{cycle}	-	-	408	1224	450	1350	t _{DOTCLK}
Vertical Back Porch	t _{VBP}	-	-	18		-	-	Lines
Vertical Front Porch	t _{VFP}	-	-	4		-	-	Lines
Vertical Data Start Point	t _{VBP}	-	-	18		-	-	Lines
Vertical Blanking Period	t _{VBP} + t _{VFP}	-	-	22		-	-	Lines
Vertical Display Area	NTSC	V _{DISP}	-	240		-	-	Lines
	PAL			280(PALM=0)				
	PAL			288(PALM=1)				
Vertical Cycle	NTSC	V _{cycle}	-	262		350	-	Lines
	PAL			313				

6.3 Signal Timing in DE Mode

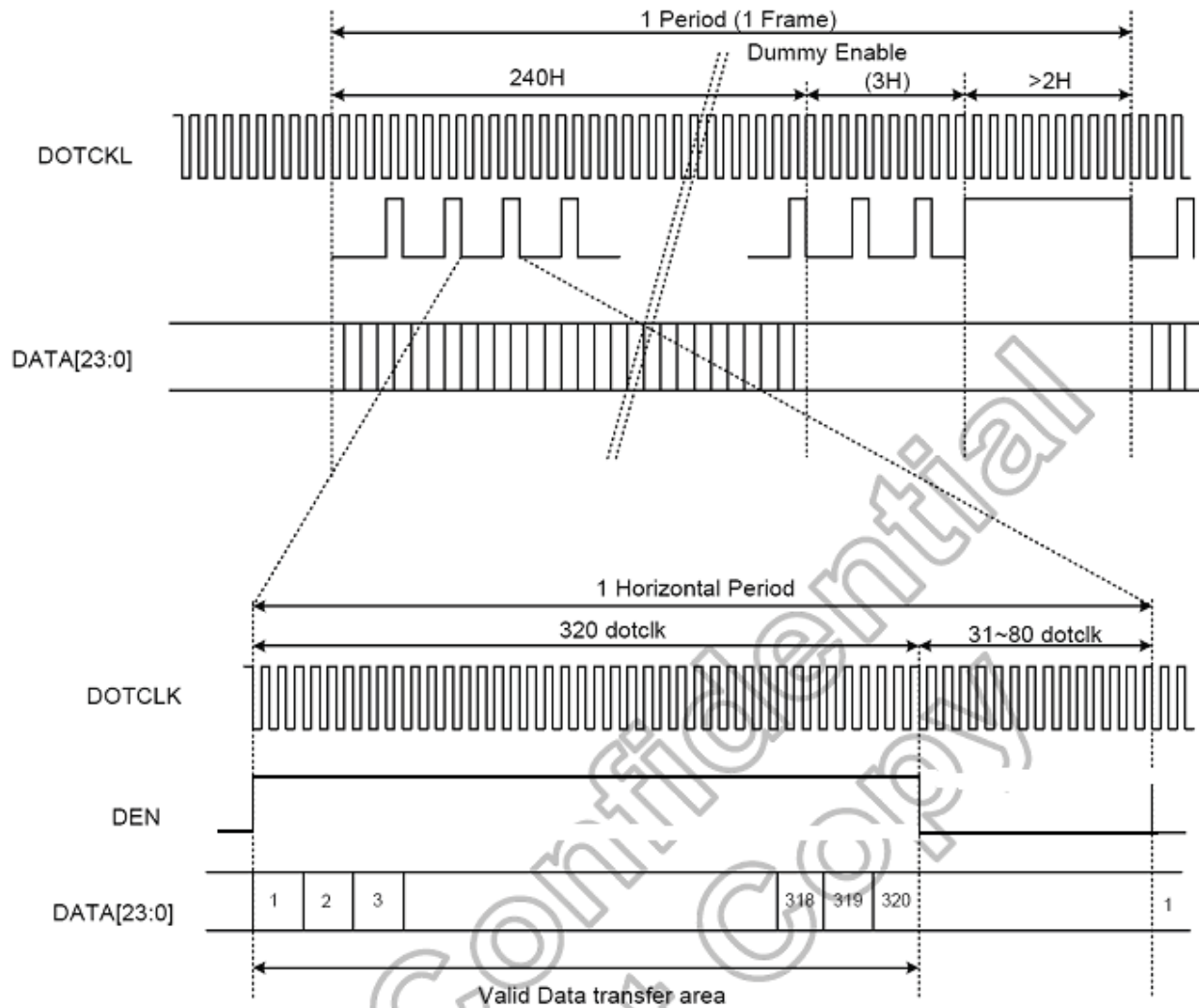

6.4 Controller Information

IC: HX8238D

Please download IC specification at <http://www.orientdisplay.com/pdf/HX8238-D.pdf>

7. OPTICAL CHARACTERISTICS

Item	Symbol	Conditions	Specifications			Unit	Note	
			Min.	Typ.	Max.			
Transmittance	T%	Viewing normal angle $\theta_x = \theta_y = 0^\circ$		7.4		%	All left side data are based on CMO's following condition -T6 NTSC: 60% LC:5091 Light : C light (Machine:BM5A) Normal Polarizer Without DBEF "Simulation Data Reference Only"	
Contrast Ratio	CR		200	300		--		
Response Time	T_R			15	30	ms		
	T_F			35	50	ms		
Chromaticity	Red		X_R	0.609	0.639	0.669		
			Y_R	0.314	0.344	0.374		
	Green		X_G	0.264	0.294	0.324		
			Y_G	0.557	0.587	0.617		
	Blue		X_B	0.102	0.132	0.162		
			Y_B	0.106	0.136	0.166		
White	X_W	0.282	0.312	0.342				
	Y_W	0.319	0.349	0.379				
Viewing Angle	Hor.	θ_{x+}		60		deg.		
		θ_{x-}		60				
	Ver.	θ_{y+}		50				
		θ_{y-}		60				

*Note (1) Definition of Contrast Ratio (CR):

The contrast ratio can be calculated by the following expression.

$$\text{Contrast Ratio (CR)} = L_{63} / L_0$$

L63: Luminance of gray level 63

L0: Luminance of gray level 0

$$CR = CR(10)$$

CR (X) is corresponding to the Contrast Ratio of the point X at Figure in Note (5).

*Note (2) Definition of Response Time (T_R , T_F):

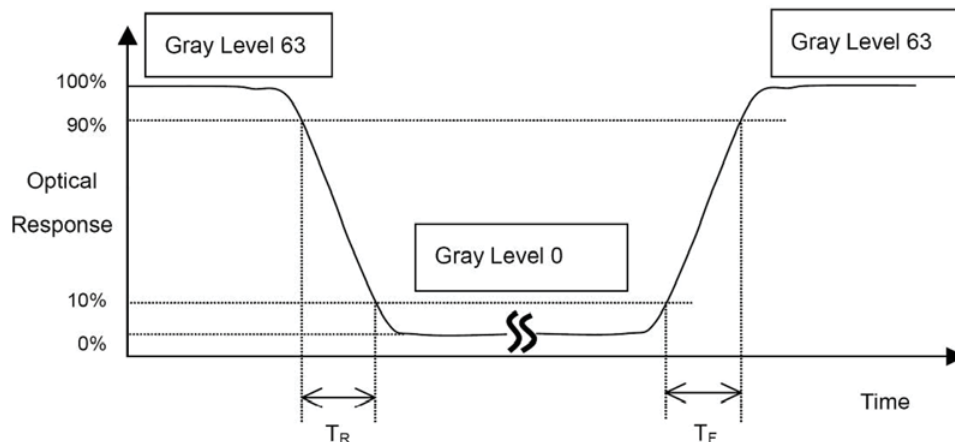

*Note(3) Definition of Viewing Angle

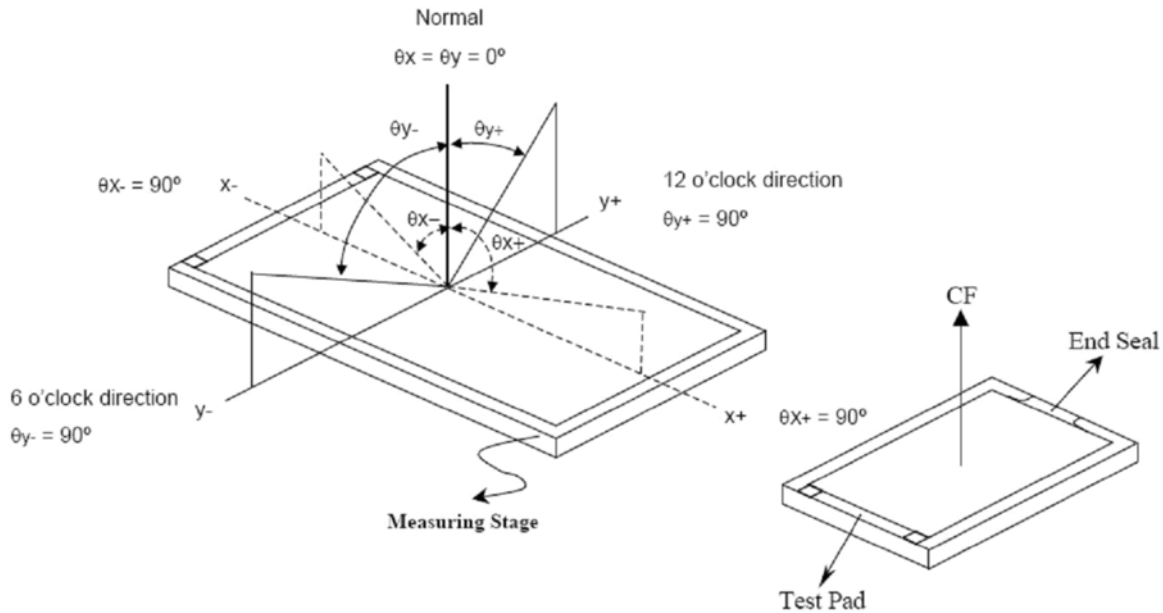

*** The above "Viewing Angle" is the measuring position with Largest Contrast Ratio; not for good image quality. View Direction for good image quality is 12 O'clock. Module maker can increase the "Viewing Angle" by applying Wide View Film.

*Note (4) Measurement Set-Up:

The LCD module should be stabilized at a given temperature for 20 minutes to avoid abrupt temperature change during measuring. In order to stabilize the luminance, the measurement should be executed after lighting Backlight for 20 minutes in a windless room.

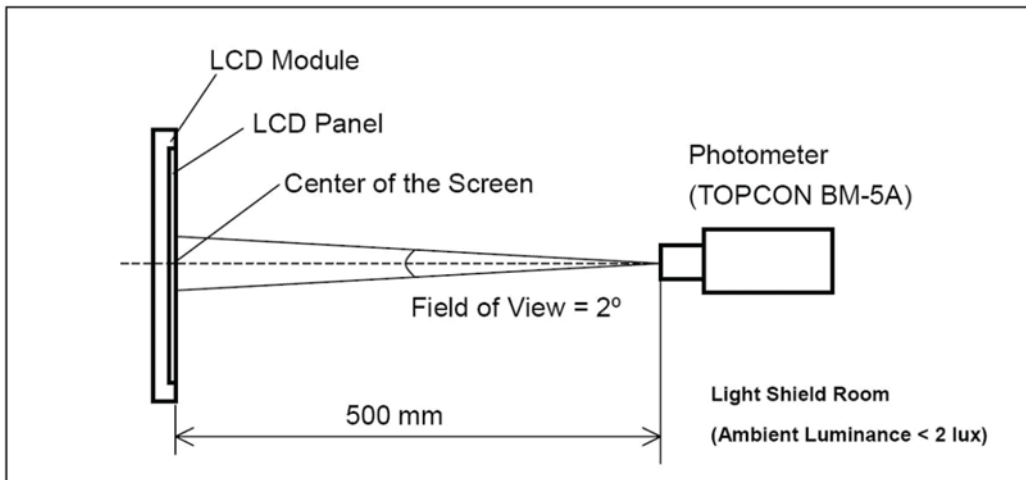

*Note (5)

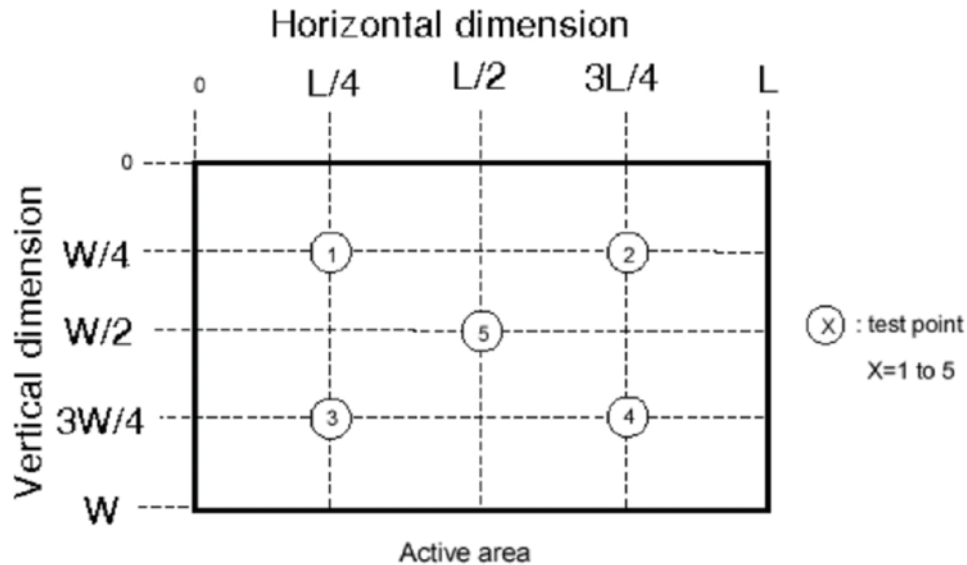

8. RELIABILITY

Please download details at <http://www.orientdisplay.com/Reliability.html>

9. SPECIFICATION OF QUALITY ASSURANCE

Please download details at <http://www.orientdisplay.com/Delivery-TFT.html>

10. GENERAL PRECAUTIONS

Please download details at <http://www.orientdisplay.com/General-Precautions.html>

11. LIMITED WARRANTY

Please download details at <http://www.orientdisplay.com/Warranty.html>

12. PACKAGE

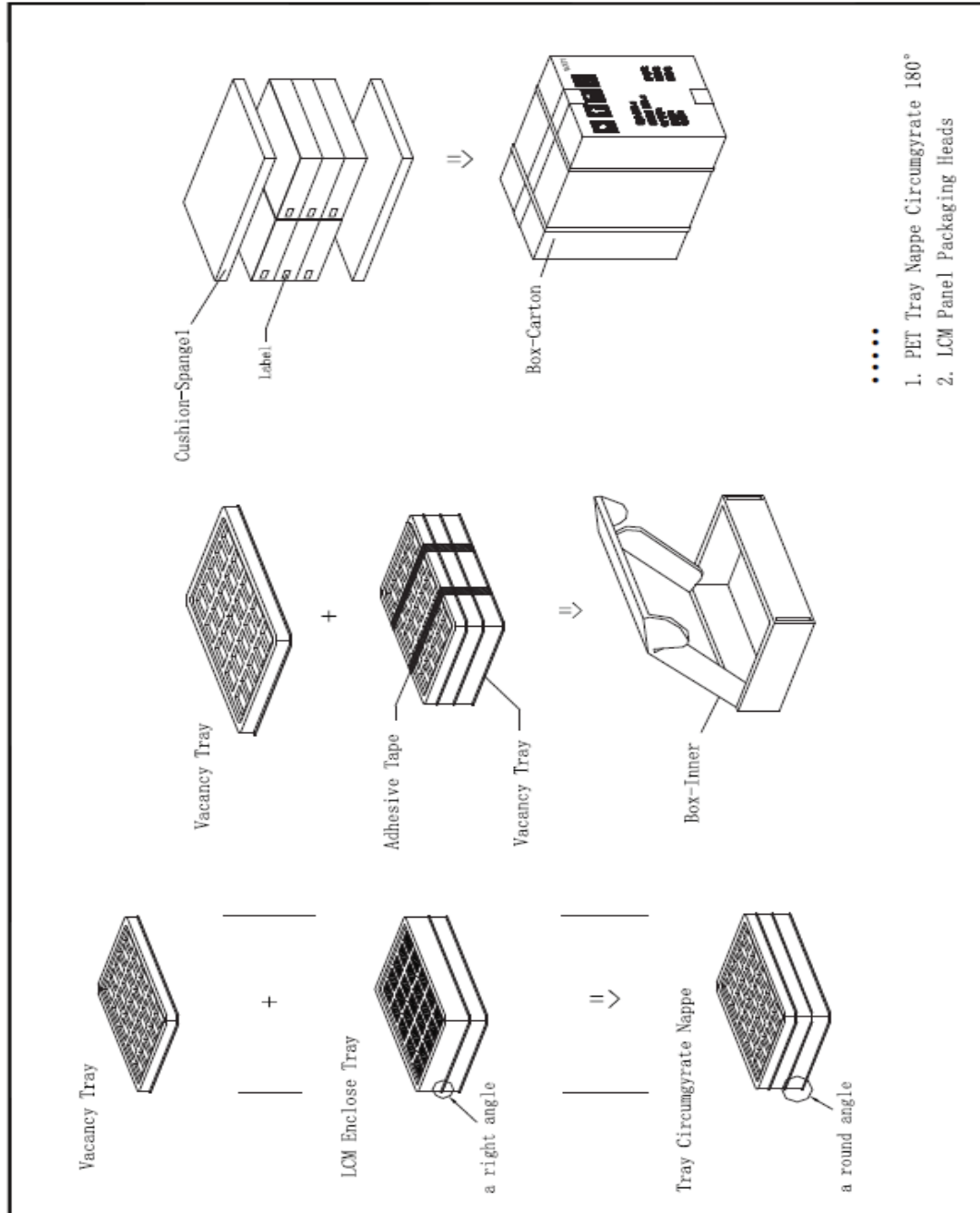

Orient Display Corporation reserves the right to change this specification.